

Manager IQ Easy Manager IQ Easy 2.0



Control unit

CONTENTS

Preface	4
Explanation of symbols	4
1 Introduction	5
2 Description and operation	6
3 Safety	8
4 Technical specifications	9
5 Systems	11
5.1 Checks	11
5.2 General	11
5.3 Fitting the Manager IQ Easy	11
5.4 Electrical installation	12
5.4.1 AC variant	13
5.4.2 24V DC variant	13
5.4.3 Connecting Devices	13
5.4.4 Machine I/O Input and output connections	14
5.4.4.1 Digital outputs	14
5.4.4.2 Remote on/off input.....	15
5.4.5 (Fieldbus) connection	15
5.4.6 Ethernet connection.....	15
5.4.7 Serial communication COM ports	16
5.4.8 Installing the protective cover	16
5.5 Mounting the Manager in a machine panel	16
6 Commissioning and operation	21
6.1 Terminology used	22
6.2 Switching on the Manager IQ Easy	23
6.3 The main screen	24
6.4 Devices	26
6.5 Operating modes	27
6.5.1 Standby and Run	27
6.5.2 Autorun mode	27
6.6 Remote on/off	28
6.7 Status information	29
6.8 (Userlevels)	31
6.9 Selecting a different (Userlevel)	32
6.10 Special Service access codes	34
6.11 Device information screens	35
6.11.1 Tab “Information” (Information) / “Settings” (Settings)	35
6.11.2 Tab “Graphics”	38
6.11.3 Tab “ActionLog”	39
6.11.4 Tab “DataLog”	40
6.11.5 Tab “Maintenance”	41

6.12 Changing a parameter	43
6.13 Overview of HMI parameters	48
6.14 Overview of Backplane / ExtensionBox parameters.....	51
6.15 Overview of common Device parameters.....	54
6.16 Switching off the Manager IQ Easy.....	56
6.17 Changing some commonly used parameters	58
6.17.1 Setting the user language of the HMI (Expert user)	58
6.17.2 Setting the system time (Expert user)	59
6.17.3 Setting the date display ((Expert user)).....	60
6.17.4 Setting a password for the 'Advanced user' user level	61
6.17.5 Setting a password for the 'Expert user' user level	62
6.17.6 Resetting the Advanced user password (Expert user).....	63
6.17.6 Resetting the Expert user password (Expert user)	64
6.17.8 Users Standby/Run control level (Expert user)	65
6.17.9 Setting Logging of Sensor Peak values (Expert user).....	66
6.17.10 Setting the Run state display colour green (Expert user).....	67
6.17.11 Reading network IP address (Expert user)	68
6.18 Linking and disconnecting Devices (Expert user).....	69
6.18.1 Linking a member with a Sensor Device (Expert user)	69
6.18.2 Linking a Sensor Device to a bar (Expert user)	71
6.18.3 Activating the CLFB voltage control (Expert user).....	74
6.18.4 Disconnecting a coupled bar from the Sensor Device (Expert user)	76
6.18.5 Disconnecting a Sensor Device from a bar (Expert user)	78
6.18.6 Disconnecting a Device from a deleted Sensor Device (Expert user).....	81
6.18.5 Disconnecting a Sensor Device from a deleted bar (Expert user)	83
6.19 Activating and deactivating sensor segments (Expert user, Sensor version V5_2 only)	86
6.19.1 Activating and deactivating sensor segments via the settings screen (Expert user).....	86
6.19.2 Activating and deactivating sensor segments via the Graphics screen (Expert user)	87
6.20 Enabling and disabling Sensor segments (Expert user).....	88
6.20.1 Enabling and disabling Sensor segments via the settings screen (Expert user)	88
6.20.2 Enabling and disabling Sensor segments via the Graphics screen (Expert user).....	89
6.20.3 Enabling and disabling Sensor segments via a linked bar (Expert user)	90
6.21 Checking and monitoring System Configuration (Expert user).....	91
6.21.1 Switching on the system configuration check for the first time (Expert user)	92
6.21.2 Saving custom system configuration (Expert user)	93
6.21.3 Temporarily/permanently deactivate System Configuration Check (Expert user).....	94
6.21.4 Re-enabling System Configuration Check (Expert user)	95
6.21.5 Temporarily disabling System Configuration Alarm notification (Expert user)	96
6.22 Setting up an FTP connection (Expert user)	97
6.22.1 Standard FTP login username and password.	97
6.22.2 Users FTP login username and password.	97
6.22.3 Setting up an FTP connection with Edge.	97
6.22.3 Setting up an FTP connection with IExplore.....	97
6.22.5 Setting up an FTP connection with Windows Explorer.	99
6.22.3 Setting up an FTP connection with FileZilla.	101
6.23 Copying log files to a USB stick.....	105
6.24 Copying log files including Simco Debug files to a USB stick (Service)	106
6.25 Backing up system parameters to USB (Expert user).....	107
6.26 Restoring system configuration from a backup (Expert user)	109
6.27 Searching for newly added Extension IQ Easy units	111
6.27.1 Searching manually for Extension IQ Easy units.....	111

6.27.2 Searching manually for Extension IQ Easy units.....	112
6.28 Disconnecting a Device (Expert user)	113
6.28.1 Device disconnected notification.	113
6.28.2 Restoring a disconnected Device.....	114
6.28.3 Removing the Disconnected Device from the IQ Easy system.	115
6.29 Replacing a defective Device (Expert user)	116
6.29.1 The Device information is still available in the memory of the Manager IQ Easy.	116
6.29.2 The Device information is stored on the system.....	116
6.29.3 There is no longer any information from the defective Device available for the Manager IQ Easy.	117
6.30 Calibrating a bar (Expert user)	118
6.31 Fieldbus settings (Expert user)	119
6.31.1 Setting up the use of a DHCP server.....	119
6.31.2 Setting the network parameters with IPconfig tool (ProfiNet and EtherNet/IP only).	120
6.31.2.1 Setting the Fieldbus network parameters using a DHCP server.	121
6.31.2.2 Setting the Fieldbus network parameters without using a DHCP server.	122
6.31.3 Setting the parameters "Domain name", "Host name" (ProfiNet and EtherNet/IP only).....	124
6.31.4 Setting the network Device name (ProfiNet only)	126
6.31.5 Setting the "Fieldbus Device ports" mapping parameter(s).....	129
6.31.6 Setting the "Fieldbus smart sensor data msg" parameter	133
6.31.7 Meaning of status LEDs Fieldbus module.....	134
6.31.7.1 Meaning of status LEDs EthetNet/IP Fieldbus module.....	134
6.31.7.2 Meaning of status LEDs of the Profinet Fieldbus module	135
6.31.8 Setting up PLC for fieldbus communication	135
7 Functional check	136
7.1 Warnings	136
7.2 Alarms	136
7.3 Data logging (as of <i>Software version V1.1.0</i> of the Manager)	136
7.3.1 Copying data from internal memory to PC.....	137
7.3.2 Data logging to USB	137
8 Maintenance	138
9 Solving malfunctions and problems.....	139
10 Repairs	142
11 Scrapping	142
Spare parts.....	143

Preface

This manual is intended for the installation and use of the MANAGER IQ EASY.

This manual describes the installation and basic menus of the Manager itself. The different possibilities of the connected equipment using the Manager is described in detail in the manual of the relevant Device.

The term 'Devices' in this manual refers to Simco-Ion 24V DC equipment suitable for connecting to the Manager IQ Easy.

This manual must be available at all times to staff operating the equipment.

Read through the entire manual before installing and commissioning the product.

Follow the instructions set out in this manual to ensure proper operation of the product and to retain your entitlement under the guarantee.

The guarantee terms are set out in the General Terms and Conditions of Sale of SIMCO (Nederland) B.V.

Explanation of symbols

The following symbols may appear in this manual or on the product.



Warning

Indicates special information to prevent injury or significant damage to the product or the environment.



Danger

Indicates information for preventing electric shocks.



Attention!

Important information for making the most efficient use of the product and/or for preventing damage to the product or the environment.

1 Introduction

The Manager IQ Easy is equipped with an on/off switch, 6 connectors for connecting Simco-Ion equipment (Devices), various I/O connectors and a 7" touchscreen as a user interface. The user interface is in colour and can be easily operated using a finger or stylus.

Using the Manager IQ Easy, Simco-Ion equipment can be configured, read out, monitored and controlled. Also, you can easily control the quality, using the data and action logging feature on the Manager. You can read out this data with an FTP connection through the Ethernet connection or copy it to an external USB drive.

Remote control is possible using an optional Fieldbus and through the machine I/O connector with which different digital and analogue in- and outputs can be configured.

To further expand the system to up to 30 Devices, the system has 2 serial COM connectors for connecting Extension IQ Easy control units.

The Manager IQ Easy is available with 24V DC input and as a universal 100-240V AC 50-60Hz version. A special version of the Manager IQ Easy is also available that can be used with 'emergency-off' installations, whereby the Manager IQ Easy remains supplied with voltage, while the Devices are de-energised in an emergency-off situation. As a result, the Devices can no longer deliver high voltage, which creates a safe environment in an 'emergency-off' situation.

Each Device port provides the 24V DC supply voltage and the communication with the Device. All Device ports and other I/O ports are controlled through the internal Backplane IQ Easy interface.

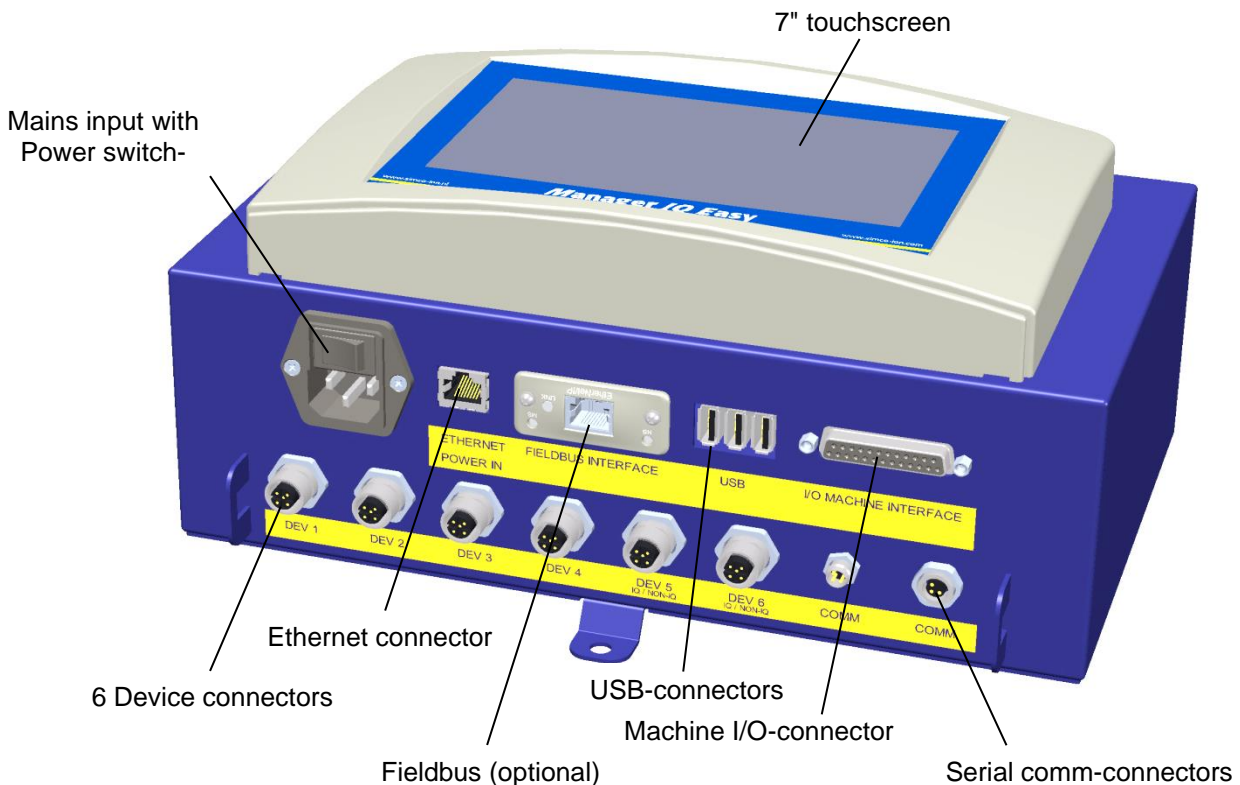

Figure 1, Manager IQ Easy

2 Description and operation

After starting the Manager IQ Easy, it will display the status of the connected equipment on the main screen.

Six possible Devices are displayed on the main screen. The operating status of each Device can be read directly through the colours and icons used.

If you require more information regarding a specific Device, you can retrieve this information by pressing the appropriate icon.



4 tabs will then be displayed. If a tab has several pages, you can scroll through them, using the



and the



buttons. Each tab contains specific information about the connected device, which will vary for each type of device. More or less information is displayed depending on the log-in level for the user level.





Information: Various parameters, settings, limit values, operation modes and current readings are displayed in a list.

Graphics: Graphical representations of current measurement values of the Device

ActionLog: List of status changes of the Device with date and timestamp.

DataLog: List of readings with date and timestamp.

Maintenance: Possible maintenance instructions.

On each tab, you can set the Device to standby  or active  mode.

Specific information of each tab is described in the manual of the corresponding Device.

3 Safety

The following safety guidelines must be observed in order to prevent physical injury and damage to objects or the Manager IQ Easy itself.



Warning:

- Electrical installation must be carried out by a qualified electrician in accordance with national and local regulations.
- The Manager IQ Easy must not be used in any environment where there are fire or explosion hazards.
- The Manager IQ Easy must not be exposed to vibrations or shocks.
- Use the Manager only in combination with matching Simco-Ion equipment.
- Also read the manual of the equipment to be connected before commissioning.
- The Manager IQ Easy is not intended as a safety component in machines.
- Do not install the manager in dirty, damp or any other areas in which chemicals or other corrosive materials are used.



Danger:

- Make sure that the equipment is properly earthed. Earthing is necessary to ensure proper and safe operation and to prevent electric shocks upon contact.
The AC version is earthed through the power cable. Plug this into an earthed outlet.
With the 24 V DC version, the earthing connector of the 24 V power connector has to be connected to the machine earthing or an earthed machine part.
- To guarantee safe operation, keep the Manager IQ Easy free of dirt, dust and moisture.
- The Device may only be serviced by qualified Simco-Ion staff.



Note:

- Making changes, adjustments etc. without prior written consent or carrying out repairs using non-original parts will invalidate the Device's guarantee.

Except for the 230 AC input connector, all connectors for the Devices and various I/O have signals that are working on a safe 24V DC.

That is why all these inputs and outputs can be connected and disconnected safely while the Manager IQ Easy is operating.

4 Technical specifications

Supply voltage	100 – 240V AC nom. (90 – 305V AC) 24V DC - 3/+10%
Frequency	50 – 60Hz nom. (47 – 63Hz)
Max power consumption	300W (100 – 240V AC version) 360W (@15A) (24V DC version)
Purpose	Industrial, indoor use
Protection class	IP52
Operating temperature	0 - 55°C
Installation	Free of dust and vibration-
Free of dust and vibration	
100 – 240V AC version	24V DC 3A max. per port, total max. 9A
Device output 24V DC version	24V DC 3A max. per port, total max. 13A
Machine I/O	
Digital inputs	10 – 30 V 25mA max.
Analog input	0 – 10V 0.6mA / 0 - 20mA / 4 – 20mA
Digital outputs	OE/OC 24V DC nom. max. 30V 25mA
USB	3x USB 2.0
Ethernet	1x RJ45 8-pin connector
Fieldbus (optional)	1x Anybus interface
Weight	5,5 kg (100 – 240V AC version) 3,9 kg (24V DC version)

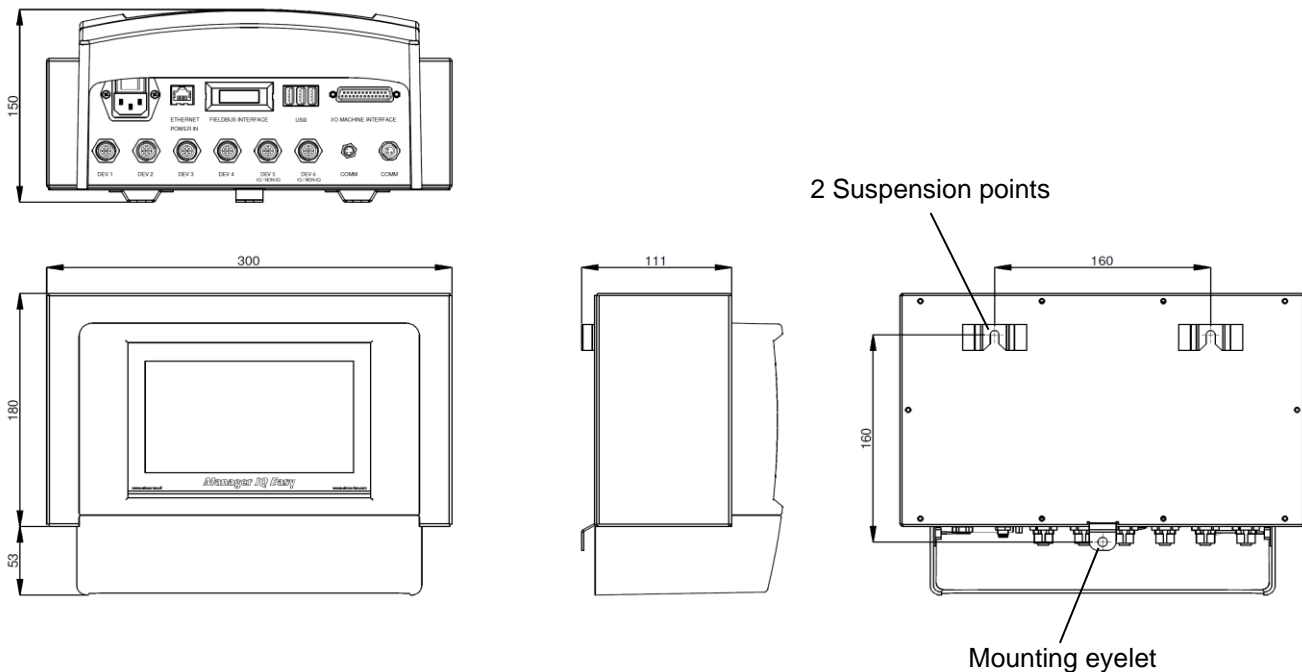

Figure 2, Dimensions Manager IQ Easy and Extension IQ Easy

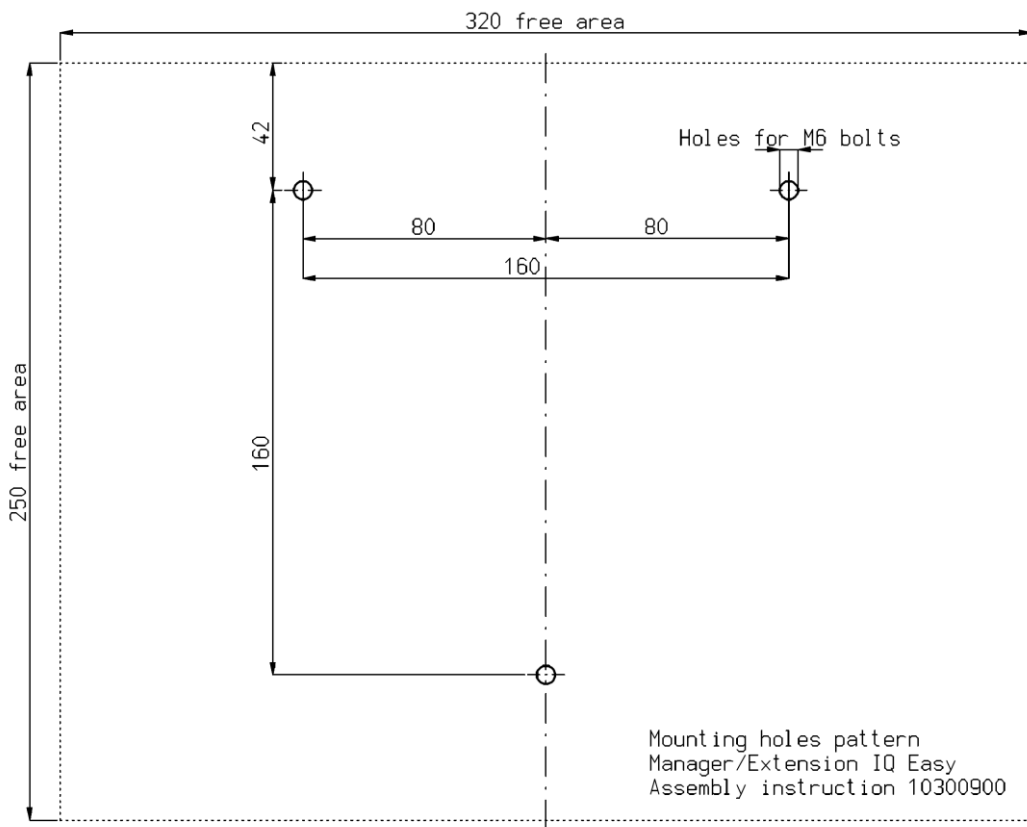

Figure 3, Drilling template Manager IQ Easy and Extension IQ Easy

5 Systems



Warning:

- The electrical installation must be carried out by an electrical engineer with the relevant training and qualifications.
- Disconnect the power supply before carrying out any work on the unit.
- Consult the manuals of the Device to be connected for proper and safe connecting and use of the Device.

5.1 Checks

- Check that the equipment is undamaged and that you have received the correct version.
- Check that the packing bill data matches the data of the product received.
- Check whether the voltage shown on the rating plate corresponds to the mains voltage you intend to use.

If you have any problems or are unsure, please contact Simco-Ion or your regional agent.

5.2 General

Place the Manager on a well visible and easily accessible place on or nearby the machine.

5.3 Fitting the Manager IQ Easy

The Manager IQ Easy can be placed on a flat surface or mounted in a machine panel.

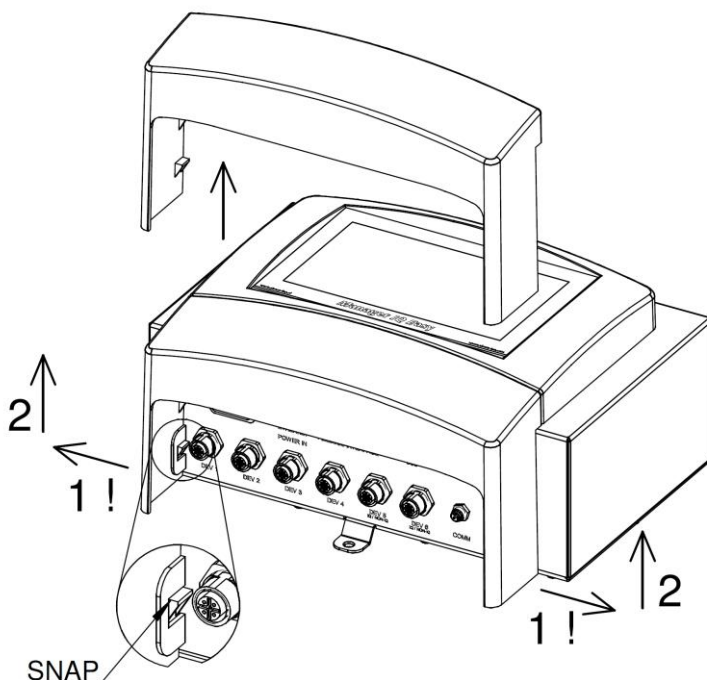

Figure 4, Removal of the plastic bottom cover Manager IQ Easy and Extension IQ Easy.

Mounting on a flat surface:

- Remove the plastic bottom cover of the Manager by bending the side flaps slightly outward and sliding the cover up.
- Use the supplied drilling templates to mark the mounting holes. Make sure that there is sufficient space at the bottom for installing the cables.
- Drill the mounting holes into the mounting surface, mount suitable bolts into the two top holes and allow the bolts to stick out 2.5 mm.
- Hang up the Manager with suspension points behind the bolt heads.
- Secure the lower mounting eye of the Manager with a suitable bolt.

5.4 Electrical installation



Warning:

- **Disconnect the power supply before carrying out any work on the unit.**
- **The electrical installation must be carried out by an electrical engineer with the relevant training and qualifications.**
- **Make sure that the equipment is properly earthed. Earthing is necessary to ensure proper and safe operation and to prevent electric shocks upon contact.**
With the AC version, plug the power cable into an earthed outlet.
With the 24 V DC version, the earthing connector of the 24 V power connector has to be connected to the machine earthing or an earthed machine part.
- **Connect the Manager IQ Easy according to the locally applicable regulations.**

5.4.1 AC variant

- Plug the power cable into the IEC connector and plug the outlet plug into an earthed wall outlet.

5.4.2 24V DC variant

- Connect the 24 V DC power connector as shown in figure 5.
- Connect the earthing (ground) point with an earthed machine part or a shared earthing point.

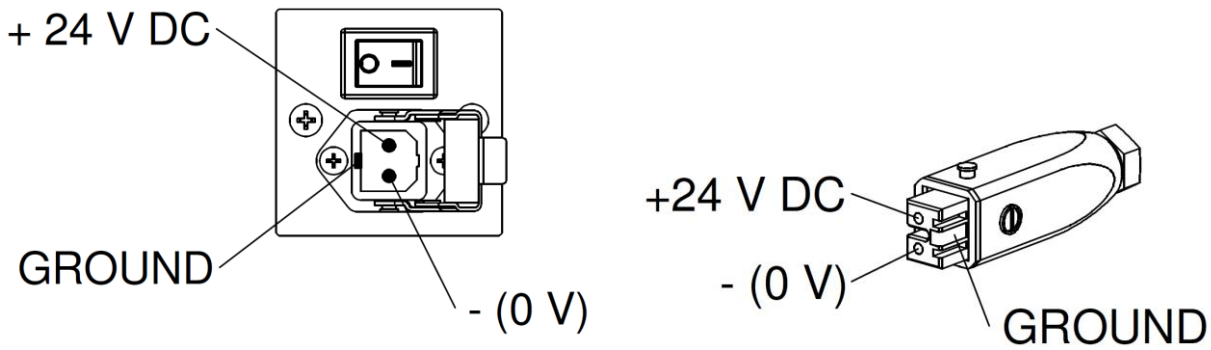

Figure 5, 24 V-input Manager IQ Easy

5.4.3 Connecting Devices

Six M12 Device ports are available for connecting various Simco-Ion Devices. Connect the Devices with the appropriate M12 Device ports 1 to 6.

Connecting is possible using standard cables with M12 5-pin male-female connectors.

The length of the cables is limited since the supply voltage of the Devices is also routed through this cable. If the desired length exceeds the maximum specified length, a cable with a larger diameter for the used wires may be selected, so that the required supply voltage is still available during operation.

For this, Simco-Ion provides separate M12 5-pin connectors for connecting these cables (the connection between the Manager and the Device is 1:1) see also Figure 6.

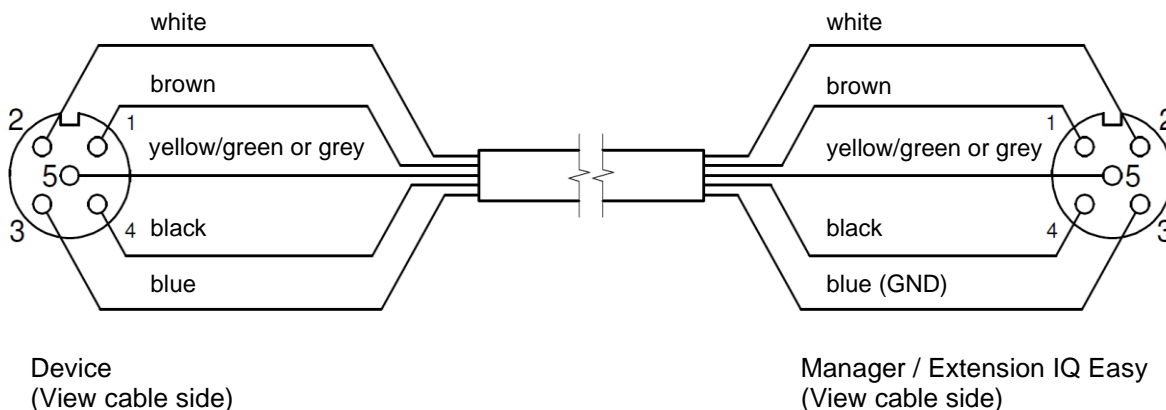

Figure 6, Wiring Device to Manager IQ Easy and Extension IQ Easy

If an old generation (non-IQ) Device is used, preferably connect this with ports 5 or 6 IQ/non-IQ. These ports can be configured so that *Remote On/Off* and operation OK feedback can be processed by the Manager IQ.

For this, use regular 1:1 male-female cables with M12 5-pin connectors as well.

5.4.4 Machine I/O Input and output connections

The Manager IQ Easy has a 25-pin Sub D connector where various in- and output signals are available. These can easily be connected to a machine controller or PLC, making it possible to transmit warnings and alarms to the machine.

5.4.4.1 Digital outputs

The digital output signals indicate the status of the Devices connected to the Manager IQ Easy and are available for connection to a machine controller (PLC).

The digital outputs can be configured in the Manager both as Open Collector (OC) and Open Emitter (OE). For this, see Section 6.12 and 6.14. By default, these are configured as Open Emitter. The output is then switched from the 24 V DC.

The PLC input can then be connected to the external GND.

For connecting these, see figure 7.

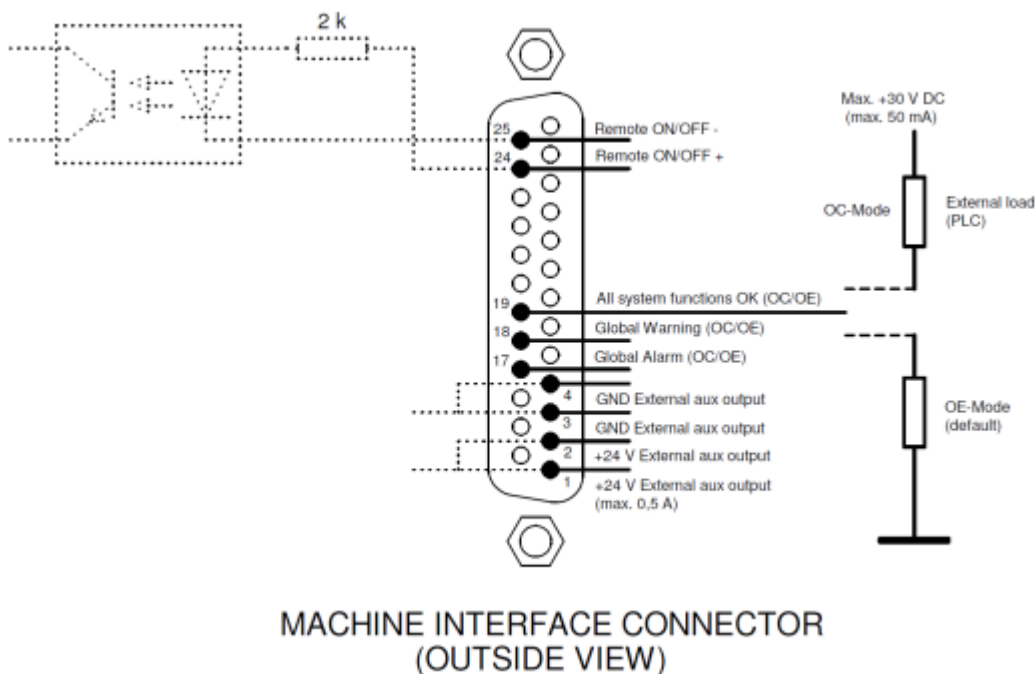

Figure 7, Wiring digital outputs on the machine interface connector

Available signals:

- 19: “**All system functions OK**” – indicates that the Manager and all connected Devices are functioning properly.
- 18: “**Global warning**” – indicates that the Manager or a connected Device is generating a warning.
- 17: “**Global Alarm**” – indicates that the Manager or a connected Device is generating an alarm.

5.4.4.2 Remote on/off input

Each connected Device can be switched via the remote on/off input. How to connect the Device with this input is explained in the manual of the corresponding Device (see the “**Remote on/off source**” parameter, Section 6.6).

- Connect an external 24 V switching signal between pins 24 and 25 (24V = Remote ON, 0V = Remote OFF)
- Or: Use the 24V DC output and connect a potential-free switching contact between pins 1 and 24 and create a connection between pin 3 and 25.

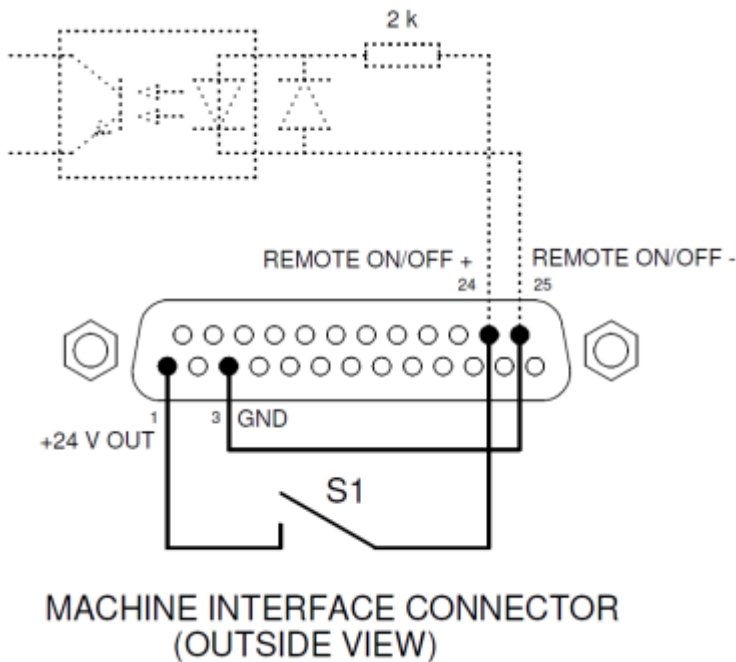

Figure 8, Wiring Remote on/off input on the machine interface connector

5.4.5 Fieldbus connection

With an optional Fieldbus connection (EtherNet/IP, ProfiNet, etc.), controls such as remote on/off, warnings and alarms can be linked to a machine control (PLC). Setpoint settings and reading back of readings are also possible when using a (Fieldbus).

For this, a (Fieldbus) interface module is mounted into the Anybus slot at the factory.

For connecting these fieldbuses, follow the general instructions applicable to these fieldbuses.

5.4.6 Ethernet connection

For transmitting datalog data from the Manager IQ Easy to a PC, the manager can be connected to a network. For wiring, a standard UTP cable with an 8-pole RJ45 connector can be used.

An Ethernet IP address must be assigned by the network (using DHCP).

For retrieving the assigned IP address, see Section 6.17.11.

5.4.7 Serial communication COM ports

For expanding the system with more than 60 Devices, two COM ports are available to which extension IQs can be connected. Standard cables with M8 3-pin male-female connectors can be used for this. These are available from Simco-Ion

5.4.8 Installing the protective cover

- When all cables are connected, the cable protection cover can be mounted.

5.5 Mounting the Manager in a machine panel

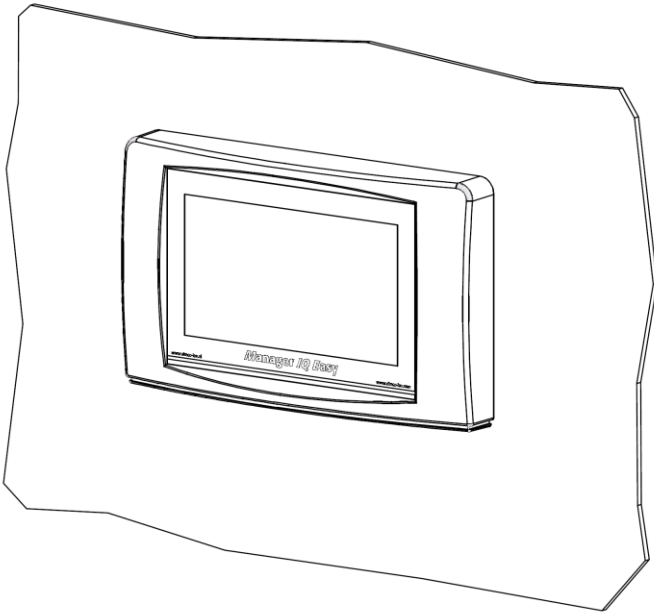
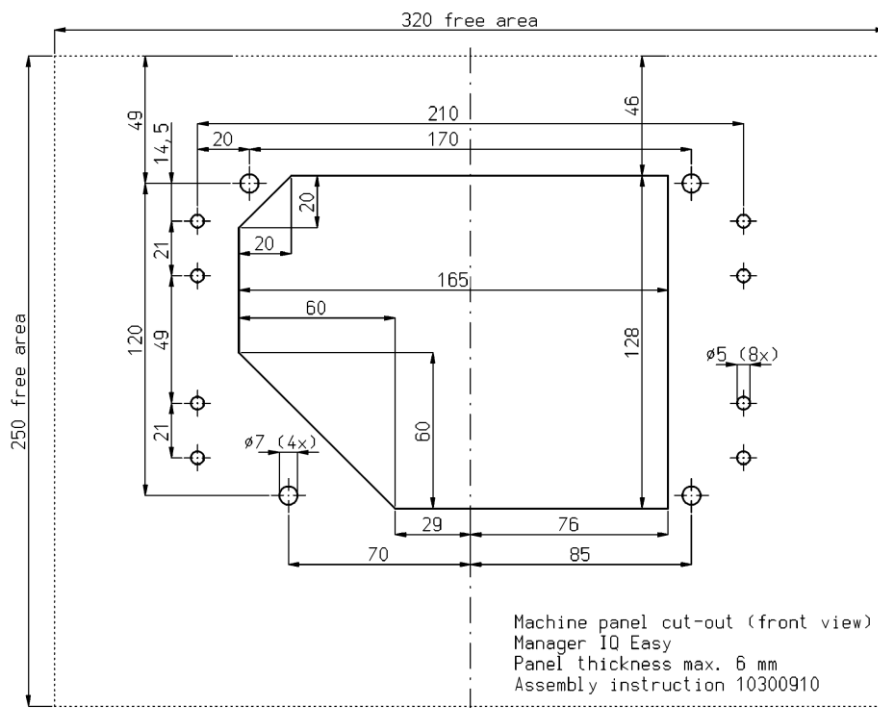

Figure 9, Manager IQ Easy mounted in a machine panel

The Manager IQ Easy can be mounted into a machine panel so that only the plastic part of the Manager is visible. The wiring will then be hidden behind the machine panel. The maximum thickness of the machine panel is 6 mm.

Follow the steps below to mount the Manager IQ Easy.

- Drill and saw the necessary recesses and holds into the machine panel. Use the supplied drilling template for this. Make sure you leave the required free space around the holes.



- The plastic front of the Manager IQ Easy is attached to the housing by means of 4 snap connectors. Carefully pull away the plastic front from the housing. The plastic part can be loosened using a larger flat screwdriver. There are two recesses below the plastic part for this.
 Note: Do not pull on the wiring between the front and the housing.

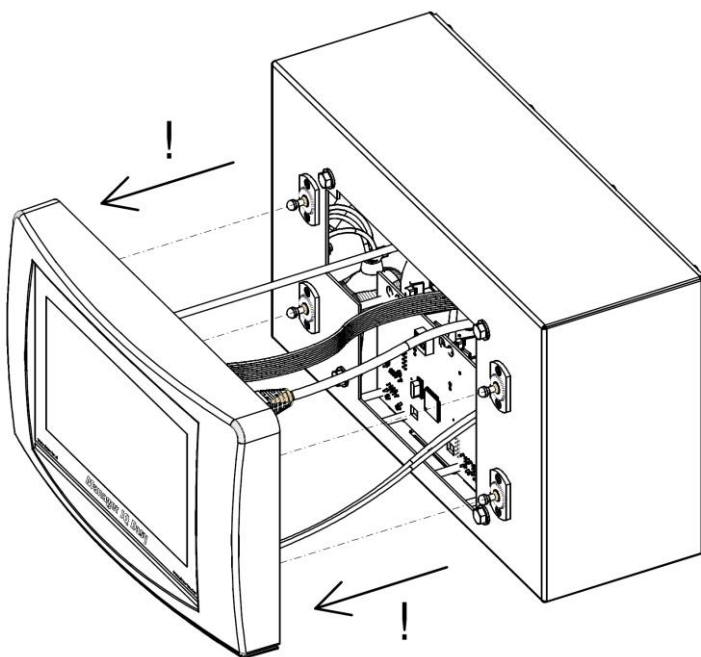

- Remove all connectors from the front.
- Remove the M5 tap bolts and washers (1) and the 4 snap connectors (2 and 3) from the housing.

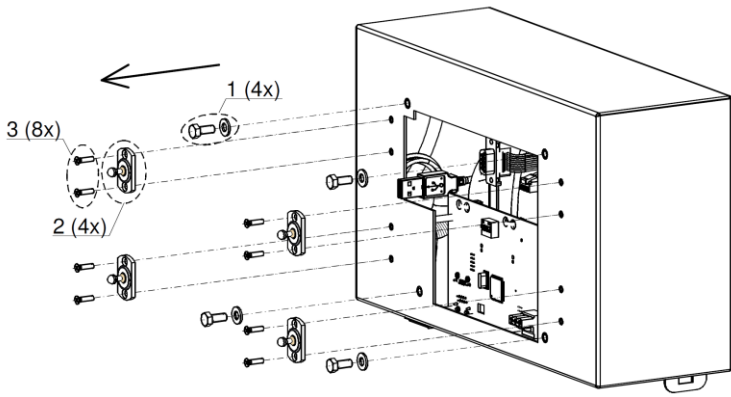

- Place the housing behind the machine panel and secure it with the 4 tap bolts and washers (1). Make sure that the wires are not squeezed between the housing and the machine panel.
- Screw the four snap connectors into the housing through the machine panel.

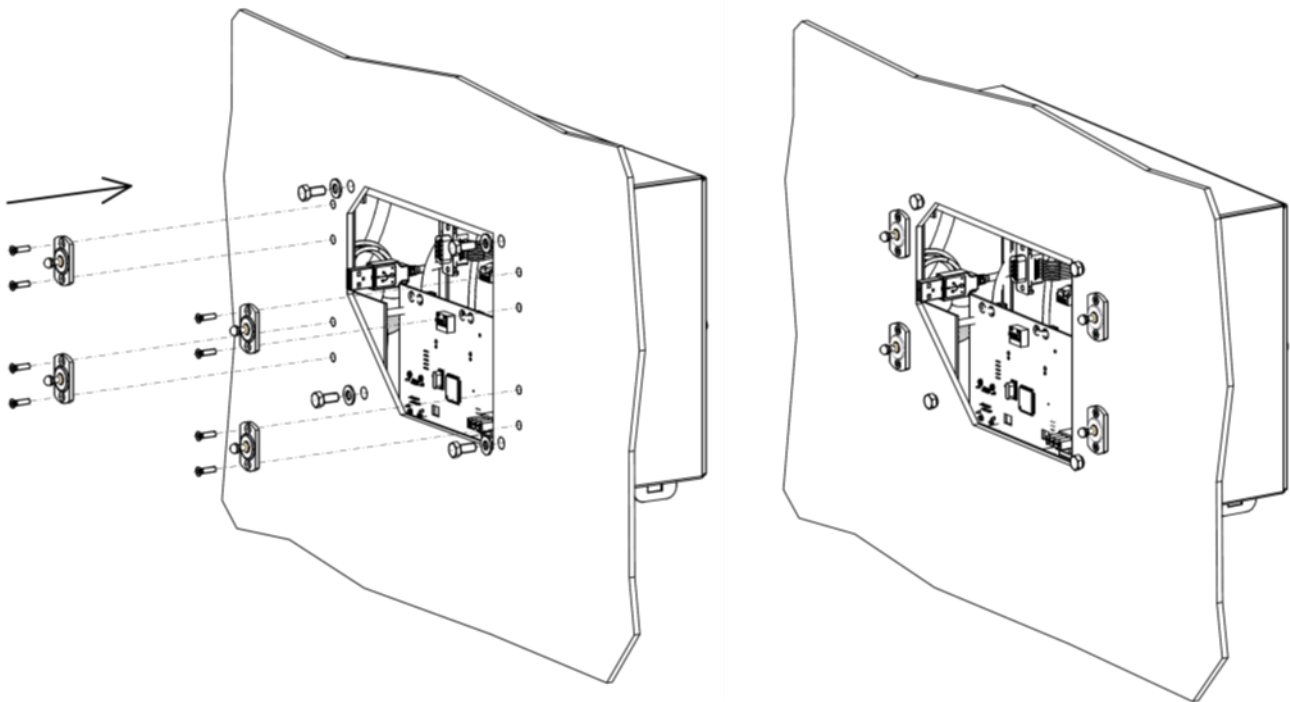

- Mount the wiring connectors from the housing back onto the front.

MAKE SURE:

The Sub-D connector at Manager IQ Easy must be on CON3

The Sub-D connector at Manager IQ Easy 2.0 must be on CON2

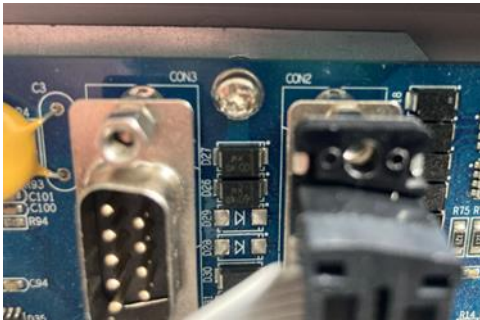

Manager IQ Easy, CON3

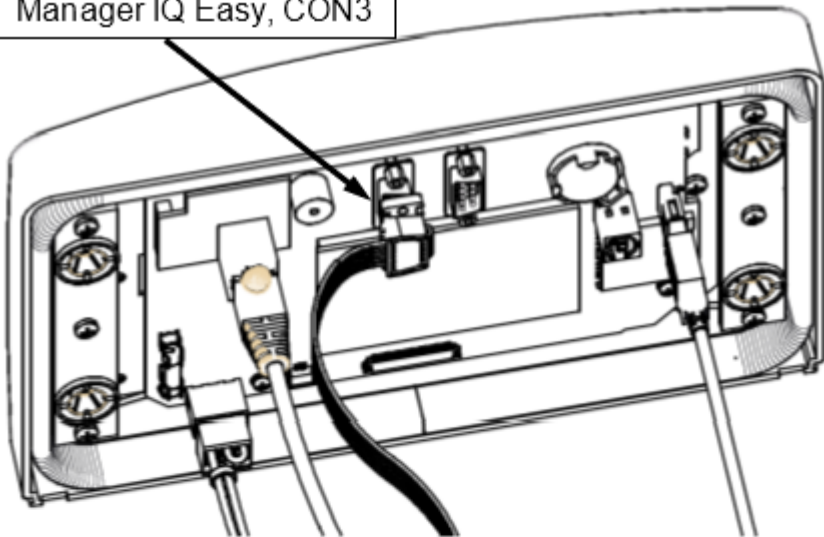

Manager IQ Easy 2.0, CON2

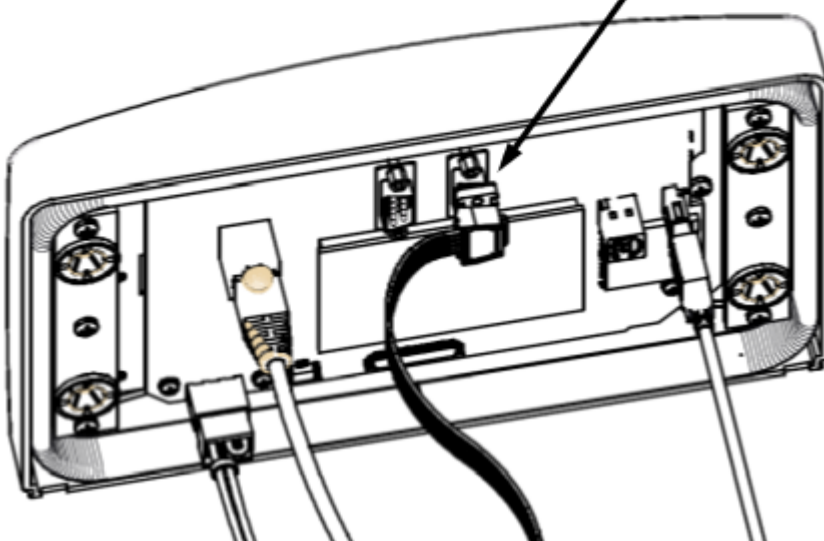

- Click the front onto the four snap connectors on the machine panel.

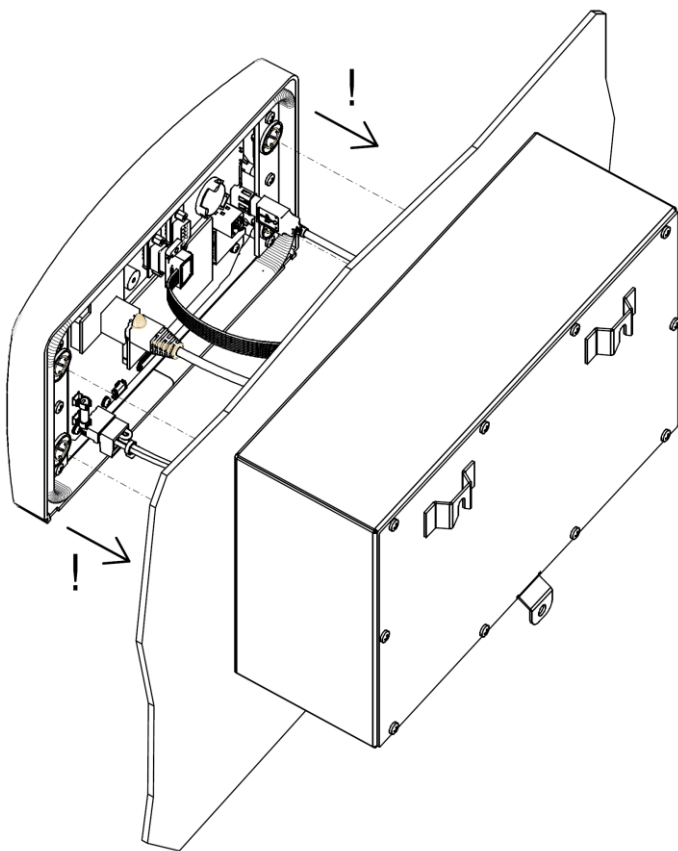

6 Commissioning and operation

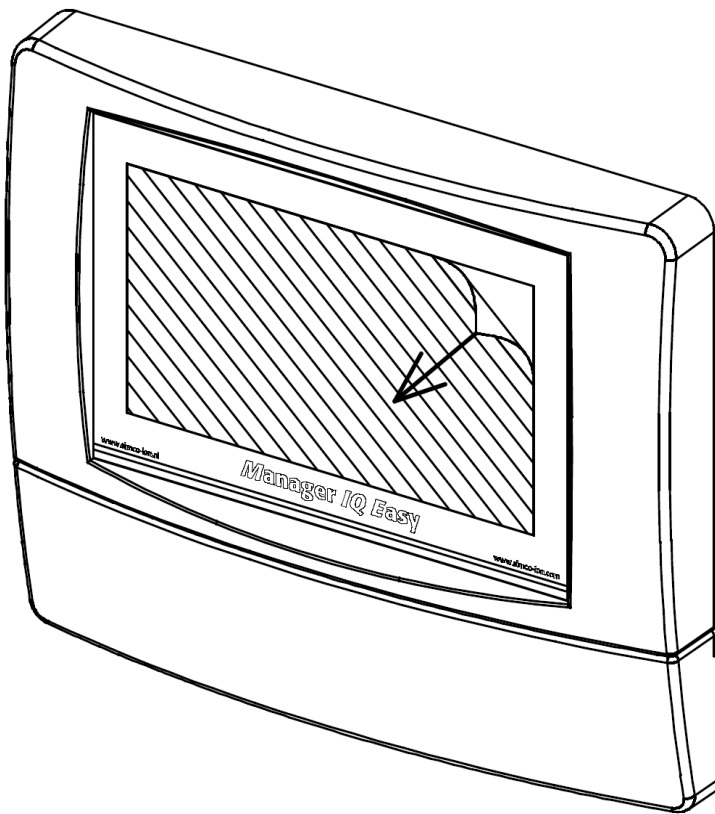

Figure 10, removing the protection film from the display

- First, carefully remove the protection film from the touchscreen.

Switching on

- Make sure that supply voltage is available in the power cable.
- Switch the Manager on using the power switch.

Note:

- **The Manager is suitable for continuous operation.**
- **Switching off the manager means that all connected Devices no longer receive the supply voltage and hence are no longer operational.**

6.1 Terminology used

Manager IQ Easy	A box consisting of an HMI and a Backplane IQ Easy. Six Devices can be connected to this box and with the help of Extension IQ Easy units it can be expanded to a maximum of 30 Devices. The Manager IQ Easy is used to control the entire system using a touchscreen display.
HMI	Human Machine Interface, the touchscreen control panel with which the Manager IQ Easy can be given instructions to operate the system. Statuses, settings and readings are also displayed.
Backplane IQ Easy	The component in the Manager IQ Easy allowing 6 Devices to be connected to the IQ Easy System.
Extension IQ Easy	(also called 'Extension Box') Extra boxes to be added with which 6 extra Devices per box can be connected to the IQ Easy System. A maximum of 4 Extension IQ Easy units can be connected to a Manager IQ Easy.
Device	Simco charging, discharging, measuring and perforation detection equipment that can be connected to the IQ Easy System.

6.2 Switching on the Manager IQ Easy

After switching on the Manager IQ Easy, it will start automatically. During the start-up of the IQ Easy System, a check will be made whether a software update can be performed. An FTP server and the Manager IQ Easy software will also be started. The FTP server can be used to copy log files to a local computer or laptop via the network. After a while the main screen of the Manager IQ Easy will appear.

As soon as the Manager IQ Easy is started up, it will automatically start searching for connected Simco-Ion (Devices). All found Devices will then be displayed on the screen. The current status of all Devices found will also be displayed on the screen.

Once the system has been started up as a whole, the various control options can be used to control the Devices. The operation of Devices can thus be activated (set to Running) or temporarily stopped (put into Standby). Where necessary, settings can be adjusted to adjust the operation of Devices.

For faster response, the Manager IQ Easy is equipped with a Remote I/O control. These inputs and outputs can be connected to a PLC to be able to report the system status of the Manager IQ Easy to the PLC, but the PLC can also control the Manager IQ Easy to switch Devices on and off faster via a Remote On/Off signal.

For advanced Remote I/O control, the Manager IQ Easy can be provided with a special (Fieldbus) interface. This allows a PLC to exert more control over the IQ Easy System. There will also be more system information about the functioning of the Manager IQ Easy and the connected Devices.

The Manager IQ Easy also has the option to store information about the operation, status messages and measurement data of the connected Devices. This information, or log files, will be stored on the Manager IQ Easy for a period of 14 days. After 14 days, the older files are automatically deleted from the Manager IQ Easy.

The user has the option to copy the saved log files via a USB stick or via an FTP network connection from the IQ Easy Manager to a local computer or laptop. There the files can then be used for analysis.

6.3 The main screen

The main screen of the Manager IQ Easy looks like this:

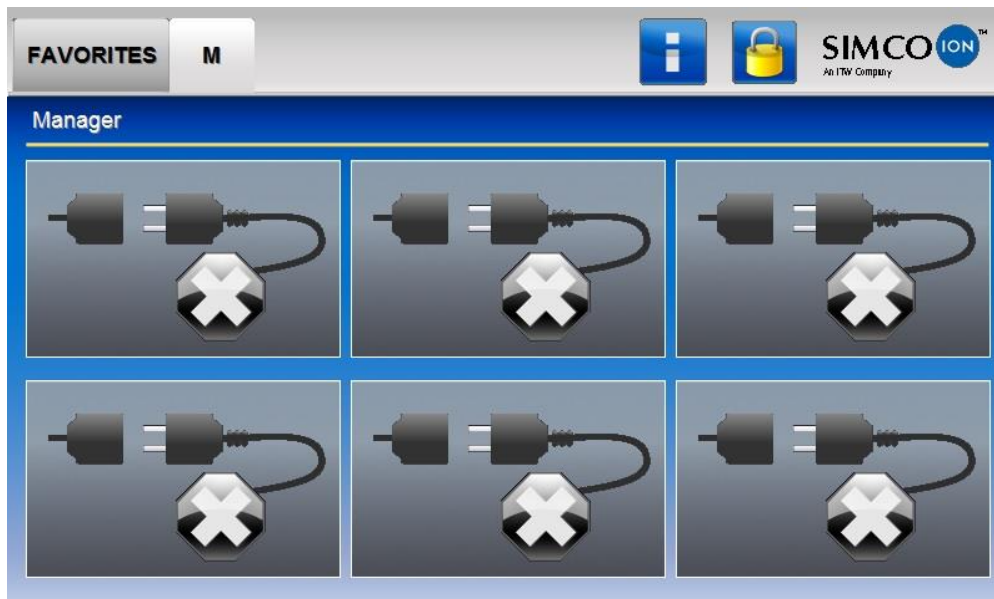

In the main screen () of the Manager IQ Easy you can find different icons and buttons. The icons indicate a status, while the buttons are used to operate the Manager IQ Easy. Below is an overview of the available icons and buttons in the main screen and the corresponding meaning or functionality.





The tab  (Favorites) can be used to display and monitor the most important Devices at a glance. In the corresponding Devices, the parameter “**Favorites screenpos**” will be set with the desired position in the “**Favorites**” tab where that Device will be displayed. The setting of parameters is described in Section 6.12.



The tab  (TabM) displays the Devices connected to the Manager IQ Easy.



The tabs  (Tab1) to  (Tab4) are only visible when the corresponding Extension IQ Easy is connected and active. The Devices connected to the Extension IQ Easy are displayed in these tabs.

If a tab is selected, it will have a light grey colour, if a tab is not selected, it will have a slightly darker grey colour. The text in the tab will be black. If a tab is disabled and therefore cannot be operated, the colour of the tab will be light grey and the text in the tab will also be light grey.



The  (Info) button is used to activate the HMI parameter screen. In combination with the



(TabM) and the



(Tab1) to





(Tab4) buttons, the



 (Info) button is also used to activate the parameter screens of the Backplane and Extension IQ Easy units. For this, see Section 6.12.







The  (Info) button can also be shown as  (Busy). At that time, the HMI is busy with a background task, such as reading in the parameters of the Backplane, an Extension IQ Easy or a Device. It can also mean that files are being copied to a USB stick, for example if a copy of all log files of the system is made.







The  (Userlevel) button is used to select a different user level.



The , ,  and  (Device) buttons display the current status of the relevant Device (Disconnected/Standby/Running/Warning/Alarm), but is also used to activate the Device Parameter screen.

6.4 Devices

The Manager IQ Easy system basically has 4 different types of Device groups. A unique icon is used for each Device group. This makes it easy for the user to recognise what kind of Device it is. The following icons are used for this purpose:





Symbol	Description Device type
	The Device is not connected.
	Neutralising equipment, e.g. Performax IQ Easy
	Charging equipment, e.g. ChargeMasterMicro IQ Easy).
	Sensor (measuring equipment) e.g. Sensor IQ Easy bar).
	Detection equipment (Perforation detector), e.g. Perfomaster).

6.5 Operating modes



6.5.1 Standby and Run

The Manager IQ Easy system has two basic operating modes. Either a Device is active and can emit high voltage, or a Device is not active and cannot emit high voltage. The active state is called 'Running', the inactive state 'Standby'.

This colour used for the operating modes depends on the parameter "**Run state display colour green**". Adjusting the parameter "**Run state display colour green**" is described in Section 6.17.10.

"Run state display colour green" value		Operating mode
No.	Yes	
		The Device is in Standby and is not active. Charging and neutralising equipment will not emit high voltage, sensors and detectors will not measure.
		The Device is in Running mode and is active. Charging and discharging equipment will deliver high voltage, sensors and detectors will measure. However, this depends on the parameter set " Remote on/off source ". By default, this parameter will be set to " Continuous " in the Device and will emit or measure high voltage. However, if the parameter is set as " Remote " or " Fieldbus ", the Device will only emit or measure high voltage if the set Remote I/O or Fieldbus input is also active.

Note:

- If the IQ Easy Manager is active in fieldbus mode, the  (Stand-by) and  (Run) buttons are disabled. The PLC will then be the master of the system via the fieldbus and will determine which Devices will be set to Standby and Run.

6.5.2 Autorun mode

Devices can have a "**Autorun**" parameter. The system will automatically put Devices that have this parameter and whose setting is set to "**Yes**" into Running mode in the event of a system startup and for a Global Run (set from the HMI parameter screen). Devices that have this parameter, but where this parameter is set to "**No**", will remain in Standby and can be set to Running mode separately via the Device parameters screen (see Section 6.11.1).

6.6 Remote on/off

The IQ Easy system has the possibility to switch Devices on and off via an external control. Two remote controls are available for this: via the Remote I/O connector or via an optional (Fieldbus) interface.









By using the Remote I/O control, Devices can be switched 'on' and 'off' faster and at the same time. It also offers the possibility to switch Devices without having to use the controls on the Manager. An external machine or PLC can use it to control the Manager and Devices.

In the Device you can use the "**Remote on/off source**" parameter to set which external controller should be used (see Section 6.12). The following values can be selected:



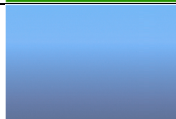
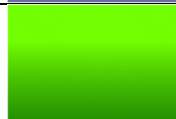







"Remote on/off source" value	Fashion
Continuous	The Device does not use any of the Remote I/O controls and will always provide high voltage in Running mode.
Input	The Device uses the Remote I/O control which is provided via a PLC on the connector. If the signal has the status 'Remote Off', the Device will not provide high voltage, if the signal is 'Remote On', the Device will give high voltage in Running mode.
Fieldbus	The Device uses the Remote I/O control which is offered via (a PLC) instruction on the (Fieldbus). If the instruction has the status 'Remote Off', the Device will not provide high voltage, if the instruction is 'Remote On', the Device will give high voltage in Running mode.

6.7 Status information

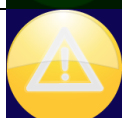

The background colours indicate the status of the connected Devices. This status depends on the parameter “**Run state display colour green**”. Adjusting the parameter “**Run state display colour green**” is described in Section 6.17.10.

“Run state display colour green” value		Status
No.	Yes	
		Inactive or no communication
		Standby, waiting for start command
		Active or Running and functions OK, without warnings or alarms.
		Active or Standby, but with a warning.
		Active or Standby, but with an alarm.

In addition to the background colours described, icons or symbols are also used to indicate the status of Devices:

Symbol “Run state display colour green” value		Description Device type
No.	Yes	
		Not connected (Disconnected) or no communication.
		The parameters and settings of the device are read in.
		Standby.
		Active or Running.
		Warning.
		Alarm.





The status of the Remote I/O control is displayed with the help of icons.

Remote icon	Definition
	The Device has no Remote I/O control (Continuous mode).
	The Device is active with Remote I/O, but the Remote I/O control is OFF.
	The Device is active with Remote I/O, the Remote I/O control is ON. However, the Device does not supply high voltage.
	The Device is active with Remote I/O, the Remote I/O control is ON and the Device puts out high voltage.

6.8 Userlevels

The IQ Easy system has 4 different (User levels). The (Basic) level will be active when the system is switched on. At this level the basic functionality of the Manager IQ Easy will be available and the user cannot change any parameters and settings. By activating a higher user level, more parameters and settings become visible and more parameters and settings can also be adjusted. The current user level is displayed by means of an icon.

The following user levels are available:

Symbol	(User level)	Access
	(Basic user)	The user can only view the parameters and settings, but cannot change them.
	(Advanced user)	The user can change a limited number of basic parameters and settings.
	Expert	The user can change all parameters and settings. This user level is intended for the Technical Department.
	Service and maintenance	This user level is normally intended for Simco-Ion staff. However, a number of special access codes have been defined, with which a special Read-only mode becomes available, or with which the Expert password can be reset.

For the user levels (Advanced user) and (Expert user), a password can be set as additional access protection.

6.9 Selecting a different (Userlevel)

To activate another user level, perform the following actions.

If necessary, go to the main screen  (Home).

Press  (Userlevel).

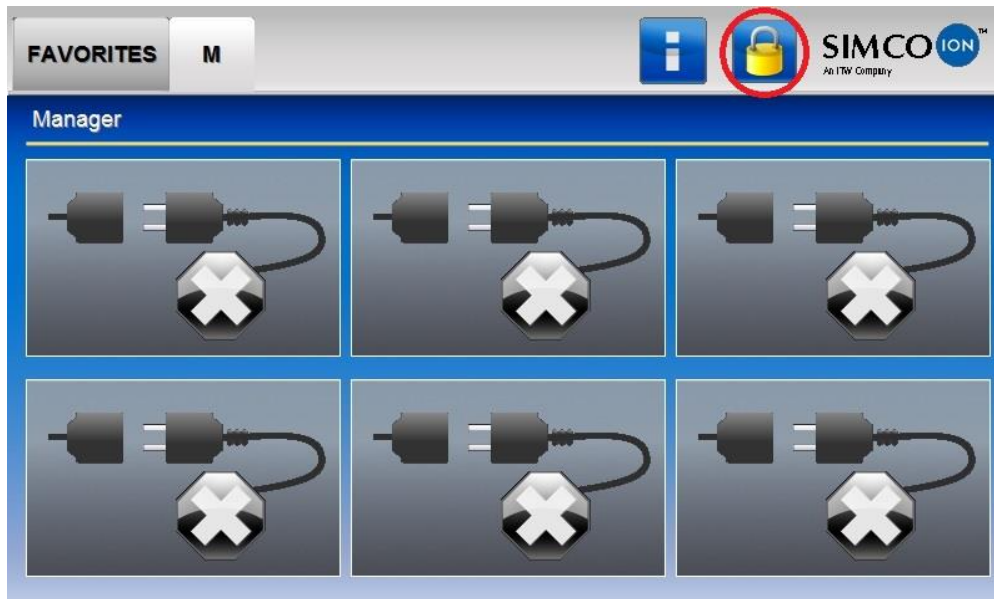

The following screen will open.







Select the desired user level (e.g. **“Basic”**, **“Advanced”**, **“Expert”** or **“Service”**).





 **Note:**

- Before the “**Advanced**”, “**Expert**” and “**Service**” user levels, a new screen may appear that requires entering a password or special access code. Then enter the password or access code and press  (Accept).

After selecting the new user level (and possibly entering a password or a special access code), the Manager IQ Easy will return to the main screen. The icon representing the user level will

now display the newly activated user level (   or ).

 **Note:**

- By default, the  (AdvancedUser) en  (ExpertUser) user levels are not password protected. To protect this user level with a password, set a password with the parameters “**Advanced password**” and/or “**Expert password**”. The setting of parameters is described in Section 6.12.

 **Note:**

- The selected user level remains active until it is modified. After maintenance has been performed on an IQ Easy system, the user level must be reset to the desired user level (Basic or Advanced).

6.10 Special Service access codes

The following special access codes are available:

Access Code	Definition
2257	All parameters and settings available for the system or Device will be displayed. This code is also used to copy the Debug files needed for Simco when copying the log files to a USB stick.
288333	This access code is used to reset the Expert password.

6.11 Device information screens

6.11.1 Tab “Information” (Information) / “Settings” (Settings)

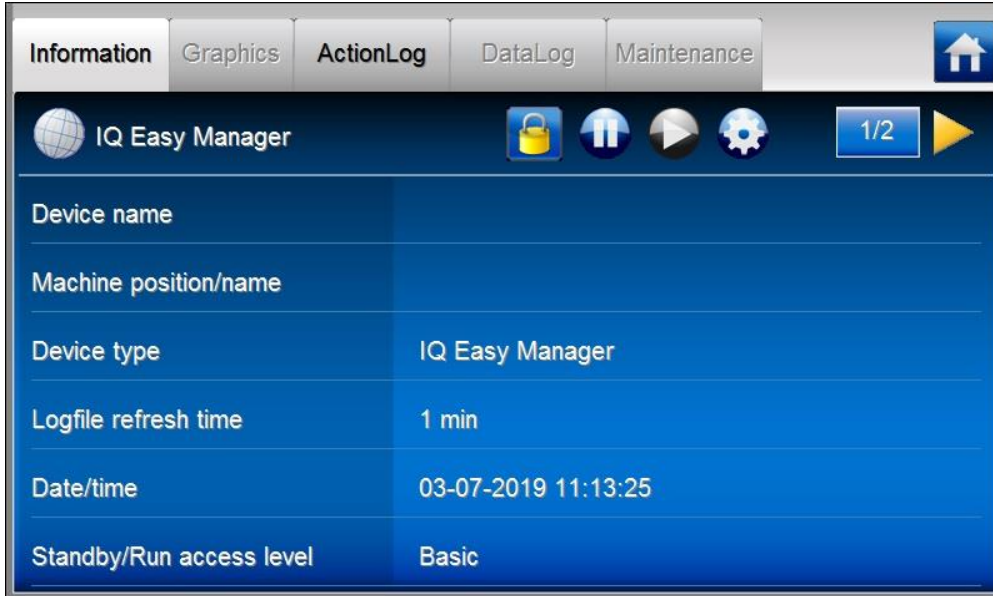

In the Information (Information) / Settings (Settings) tab, the available parameters and settings of the Device are displayed.







Note:

- If an “**Undefined param**” appears on the info screen of a Device on the Manager, the Manager must be updated with the latest software. To do so, please contact Simco-ION via <https://www.simco-ion.co.uk/contact/send-a-message/>

The Information (Information) tab contains the following icons and buttons.

Click  (Home) to return to the main screen. The button can have a different colour; for example,  if the IQ Easy system has a (Warning), or  if the IQ Easy system has an (Alarm).

The  indicates the Device type (in this case the HMI “**IQ Easy Manager**”). With a Backplane, an ExtensionBox or one of the Devices, not only will the relevant icon be found here, but the status of the Device will also be displayed by means of a background colour and a second icon.

The  (Userlevel) displays the current user level (Userlevel). In this case it is the basic user (Basic user), but it can also be   be  for one of the other user levels. See Section 6.8 for an explanation of the user levels.



Click (Stand-by) to put a single Device or the whole system (all Devices) in Standby mode.



Click (Run) to set a single Device or the whole system (all Devices) to Run mode

Parameter screen	Button	Button
HMI	Put all Devices in Standby.	Put all Devices whose parameter "Autorun" is set to "Yes" in Running.
Backplane / Extension IQ Easy	N/A	N/A
Device	Put the Device in Standby.	Put the Device in Running.



Click (EditMode) to change the parameter. The tab (Information) will also change to (Settings).



Press (Info) to return to the (Read-only) or (Information) mode. The parameters and settings can no longer be changed. The tab (Settings) will also change to (Information).



The parameter screens usually consist of multiple pages. Press and to scroll between the different pages. The current page is displayed between the two buttons and also the total number of available pages (e.g. means page 3 of a maximum of 6 pages).

To make it easier and faster to browse between the different pages, there are 2 invisible buttons available in the parameter screen. In the following image, the areas of these fields are marked in red.

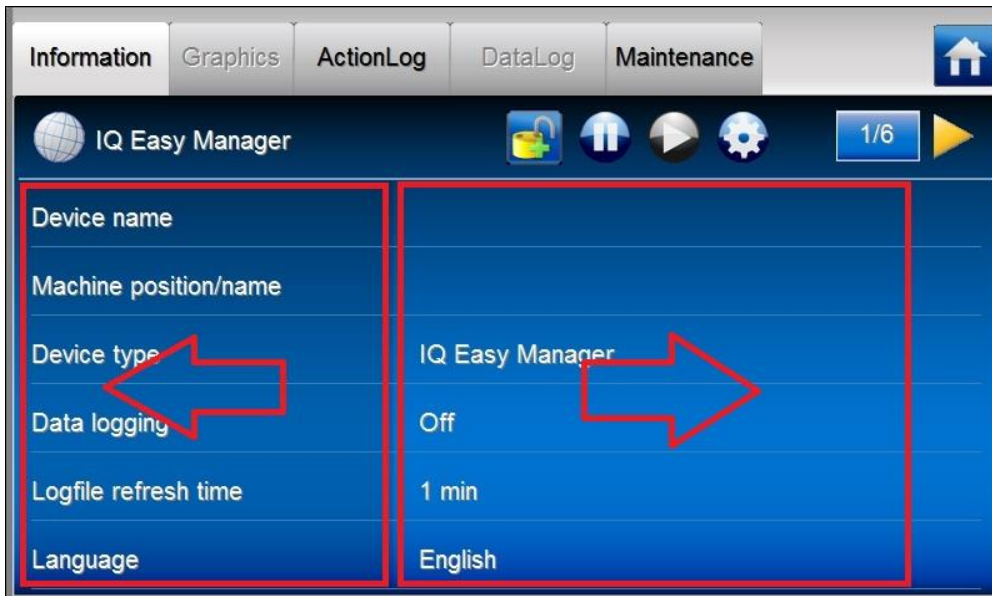

Press the button indicated by the left arrow to go to the previous page. Press the button indicated by the right arrow to go to the next page.

In the parameter screen of the Devices, an additional icon is included, which shows the operating mode and status of the Device.

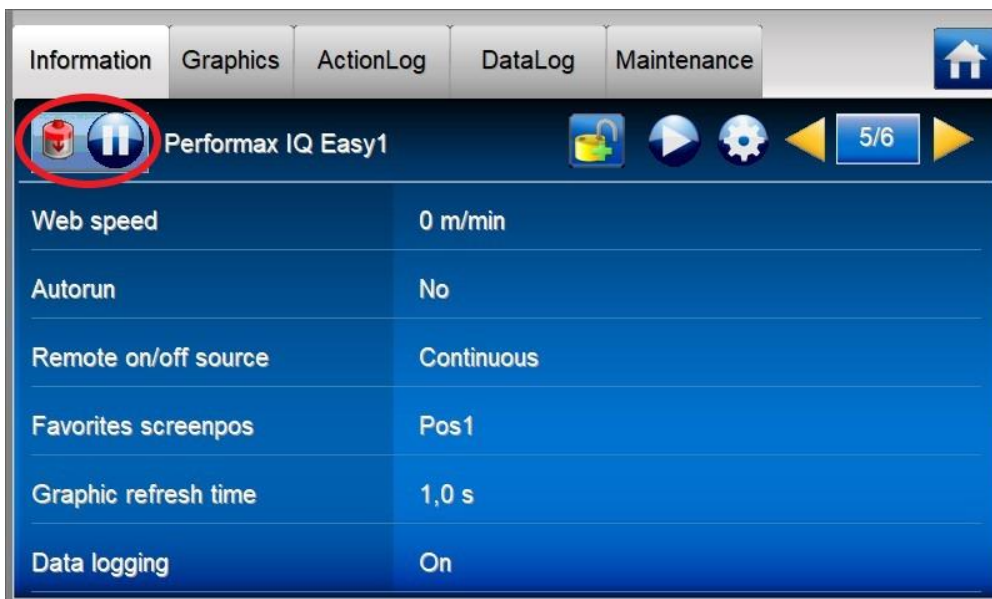

The Manager IQ Easy has several tabs for the Devices, to be able to display more information about the Device.

6.11.2 Tab “Graphics”

The “**Graphics**” screen graphically displays the operation of the Device. The graph shows important measured values in relation to time, in the case of a Sensor, the current measured values. In the key it is made clear what the representation of each coloured line is.

Press  (Graphics) to display the graphical display. For a Sensor IQ Easy the screen looks like this:

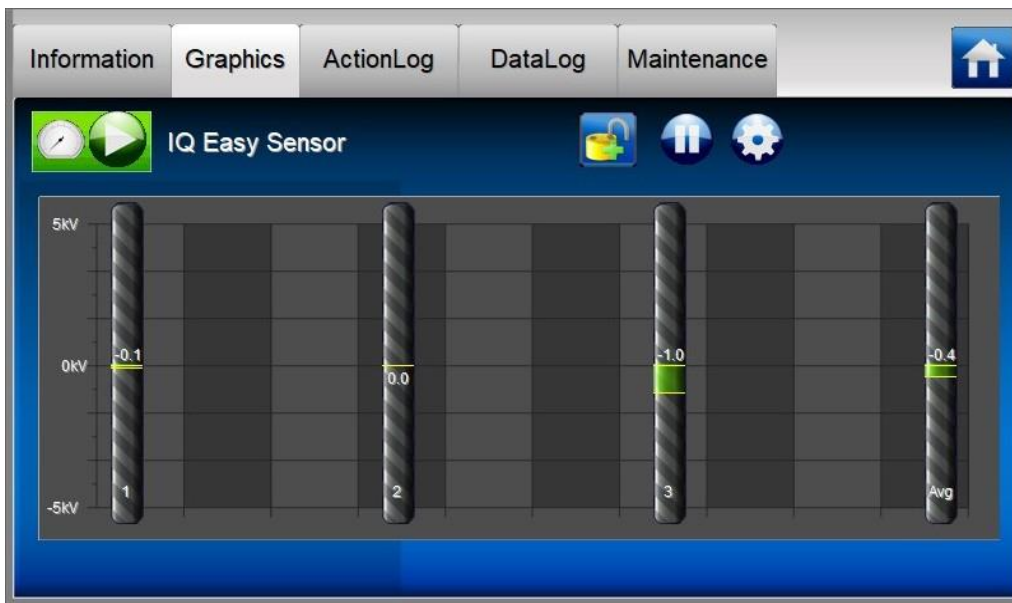

For a Performax IQ Easy the screen looks like this (note: the display will differ per Device).

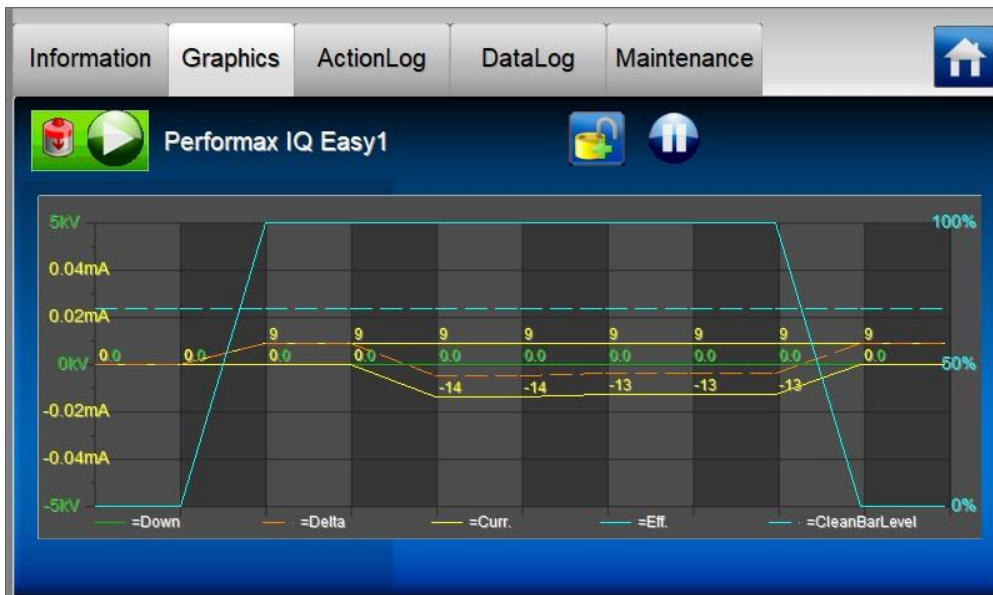

The current display can be ‘frozen’ or stopped by pressing anywhere on the graph field. The text “**On hold**” then appears on the screen. By pressing the graph field again, the text “**On Hold**” will disappear and the current values will be displayed again.

The speed at which the graphical screen is updated is set using the Device parameter “**Graphic refresh time**”. By default, this is set to 1 second. See Section 6.12 on how the parameter can be changed.

6.11.3 Tab “ActionLog”

The “**ActionLog**” saved tab stores the different actions step by step, such as whether the Device is in Running mode or Standby mode, whether the Remote input is active or not, and whether high voltage is output. In the event of any warnings or alarms, it is also indicated here what is going on. All status changes contain a date and timestamp, so that you can find out when a certain action has been carried out or reported.

Press  (ActionLog). The following screen will now be displayed:

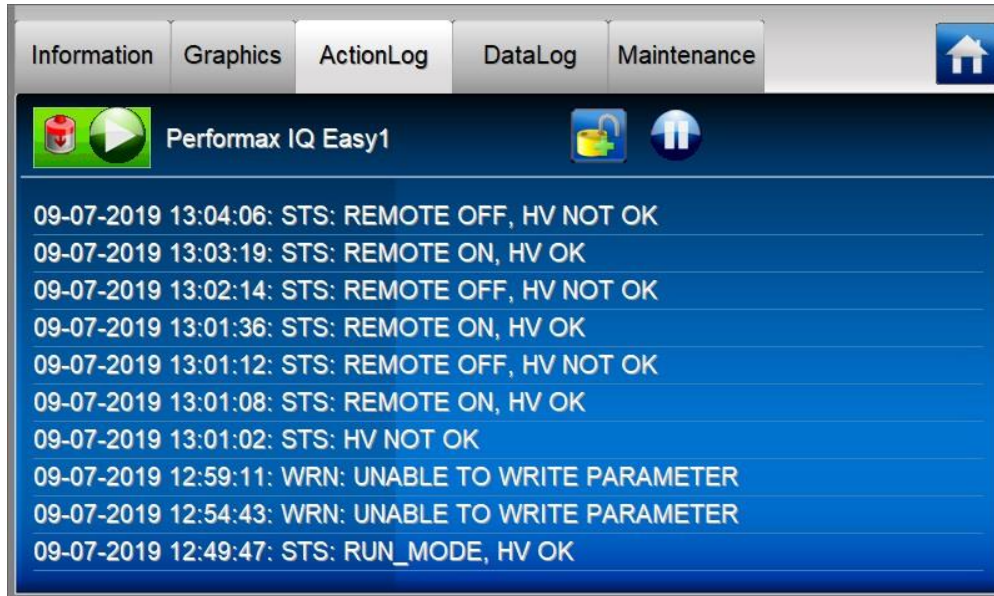

The following abbreviations are used on the screen for the type of notifications:

- MSG = (Message)
- STS = (Status)
- WRN = (Warning)
- ALM = (Alarm)

6.11.4 Tab “DataLog”

The “**DataLog**” tab is used to store the measurement values that are important for the Device at a fixed time interval. The last 10 registrations can be found in this screen. The saved measured values can also be found in a log file of the Device.

Press  (DataLog). The following screen will be displayed.

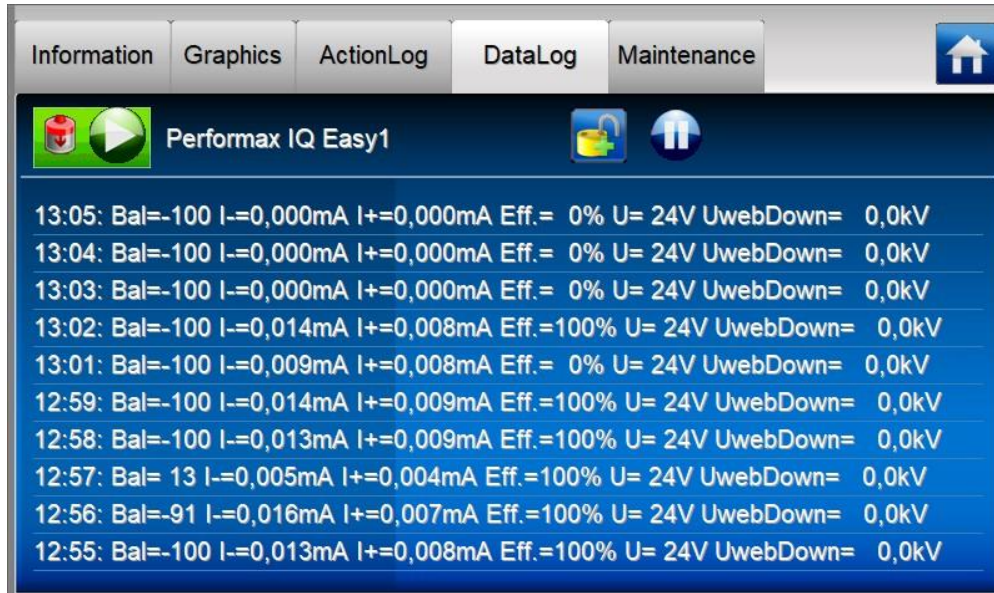

To log and save the measured values, the parameter “**Data logging**” must be set to “**On**”.

The time interval between the measured values can be set with the HMI parameter “**Log file refresh time**”. By default, this interval is set to 1 minute.

See Section 6.12 on how the parameter can be changed.

6.11.5 Tab “Maintenance”

The “**Maintenance**” tab allows you to perform maintenance instructions on the IQ Easy System or a Device. For example, a Performax IQ Easy bar can be recalibrated if this bar displays the

warning “**Calibrate bar**”. Pressing the Action button  located behind the Action “**Calibrate bar**” will start the calibration of the bar (see Section 6.30).

Press  (Maintenance). The following screen will now be displayed:

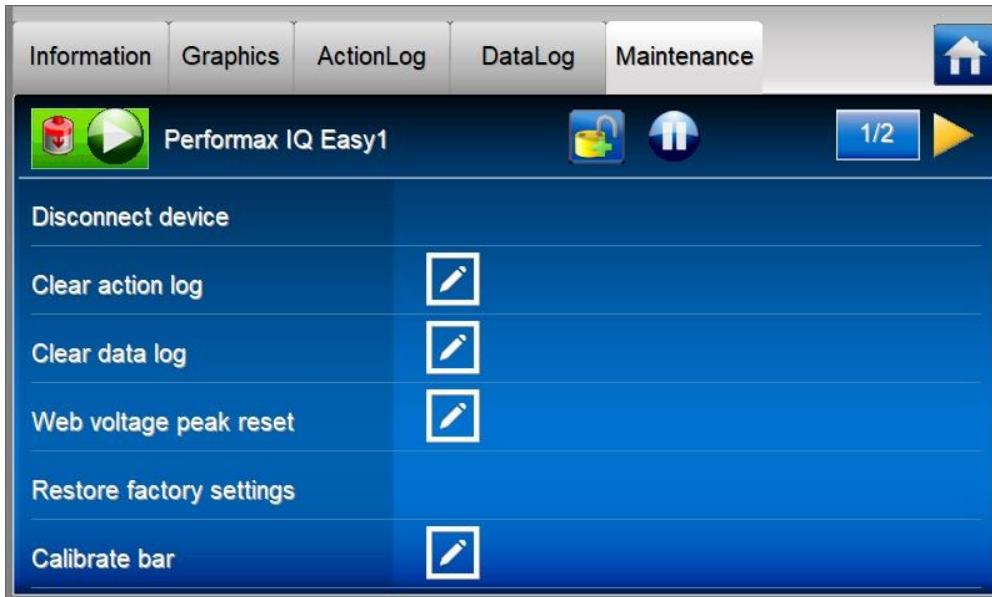













The following Actions are possible:



Disconnect Device	Action with which a “disconnected” Device can be permanently removed from the system.
Clear action log	Delete the ActionLog buffers; See tab “ ActionLog ”.
Clear data log	Delete the DataLog buffers. See tab “ DataLog ”.
Web voltage peak reset	Delete the peak value buffers from the Device.
Restore factory settings	Resets the Device parameters and settings to the factory settings.
Scan Ext. Boxes	(HMI only) Search for newly connected Extension IQ Easy units to include them in the system. Use this Action when the “ Rescan Ext.Box timer ” is set to 0 seconds.
Calibrate bar	Start calibrating the bar.
Reboot device	Restart the Device.
Update firmware	This Action is currently not supported.
Save HMI settings	(HMI only) Copy all HMI, Backplane, Extension IQ Easy and Device parameters and the configuration information to a USB stick.
Restore HMI settings	(HMI only) Restore all HMI, Backplane, Extension IQ Easy and Device parameters and configuration information from a USB stick.

Save configuration	(HMI only) Save the current configuration of the system so that it can be checked whether it is still valid. See also parameter “Check last configuration” .
Clear system alarm	(HMI only) Use this Action to clear a System Configuration Alarm. See also parameter “Check last configuration” .
Adjust Sensor 0-point	(Sensor only) See the manual of the Sensor IQ Easy for an explanation of this function.

6.12 Changing a parameter



To go to the HMI, Backplane, Extension IQ Easy or Device parameter screen, do the following:

HMI	Press  (Info).
Backplane	Press  (TabM) and <u>press  (Info) within 1 second.</u>
Extension IQ Easy	Press the relevant tab:  (Tab1),  (Tab2),  (Tab3) or  (Tab4), and <u>press the  (Info) button within 1 second.</u>
Device	Press the icon of the Device  ,  ,  or  .

In the following example, the HMI parameter screen is open. Browse to the desired page using the  and  buttons. It is also possible to use the large non-visible areas to browse.

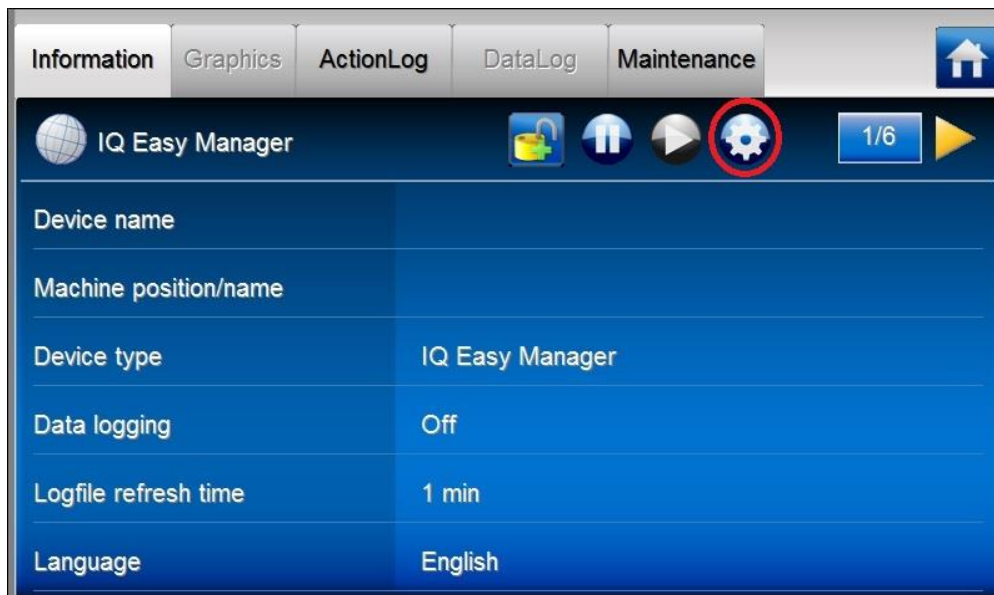
Click  (EditMode) to change the parameter.



The tab  (Information) has been changed to  (Settings) and next to the parameters that can be adjusted, there is a  button visible.

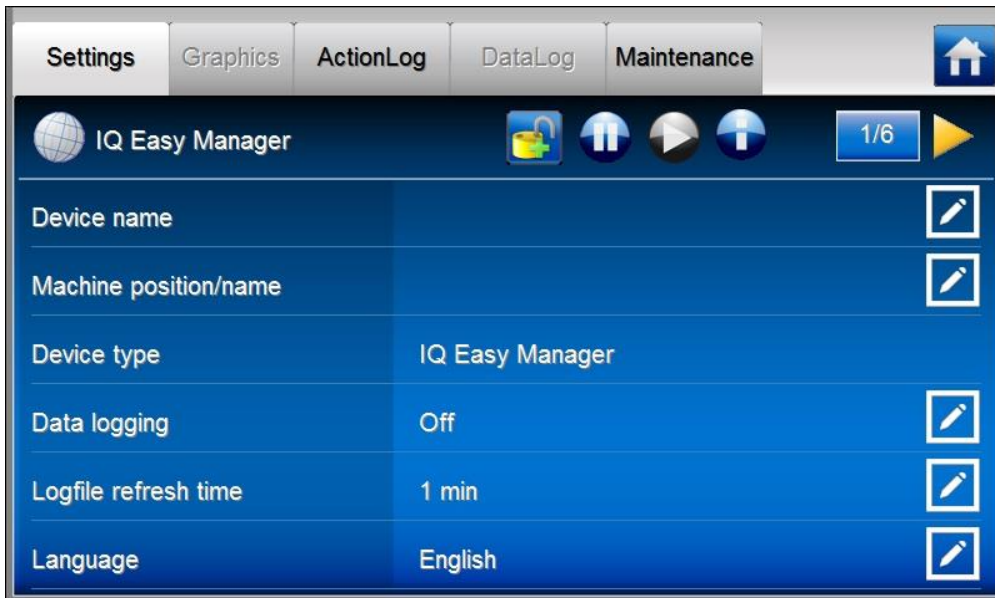

Press the  of the relevant parameter to be able to change the setting.



In the example we are going to change the name of the HMI. Press the  to the right of the parameter “**Device name**”.



A new screen will open depending on the type of parameter. For this parameter it will be a keyboard with which the name can be entered.

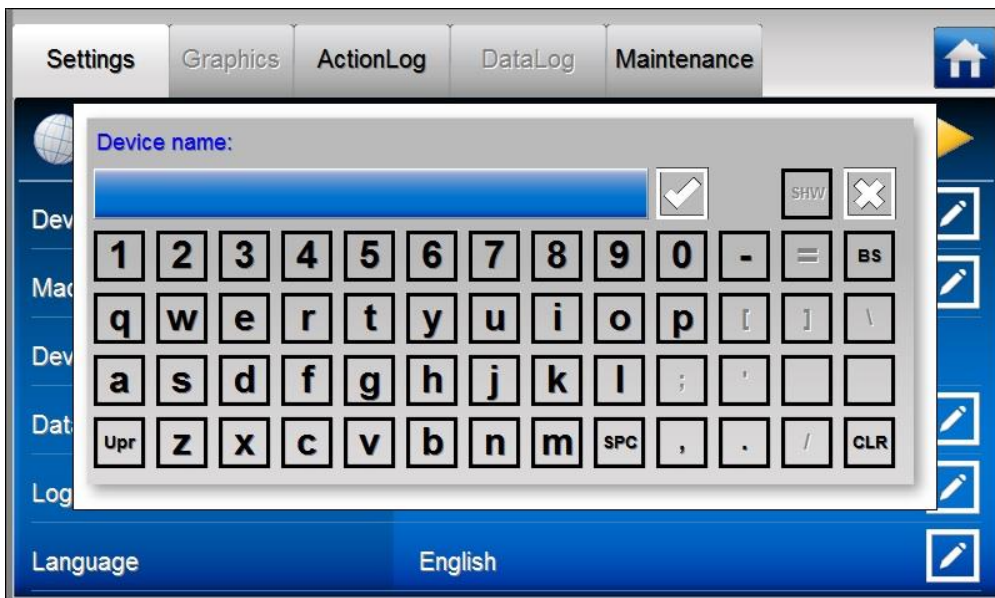

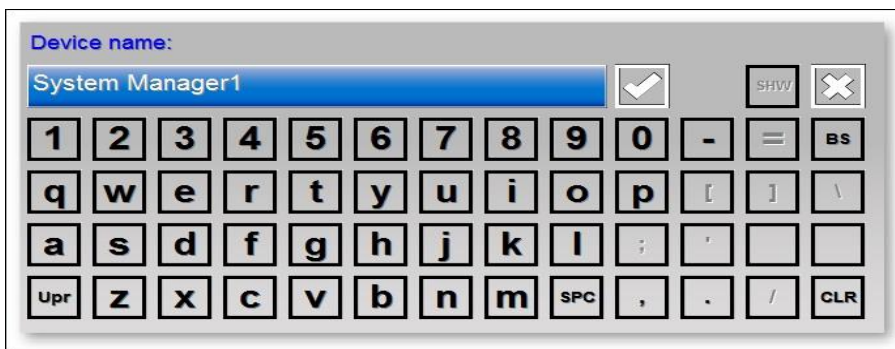

Now enter the desired name (e.g. **“System Manager1”**).





The following special keys are available:

Press  (Backspace) to delete the last character.

Press  (Clear) to delete everything.

Press  (Space) to enter a space.

Press  (Upper) to switch to capital letters and special characters.

Press  (Lower) to switch to lower case and the numeric keys.

Press  (Show) to make the password visible.

Press  (Hide) to hide the password.

Press  (Cancel) to not save the changes and return to the parameter screen.

Press  (Accept) to confirm the entered name.

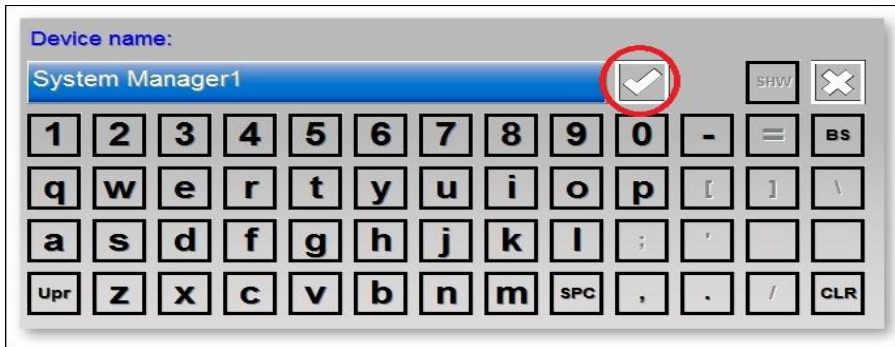

The adjustment made will be visible in the parameter screen.





Click  (Home) to return to the main screen.

Depending on the type of parameter, a different input screen will appear. Some common screens are:

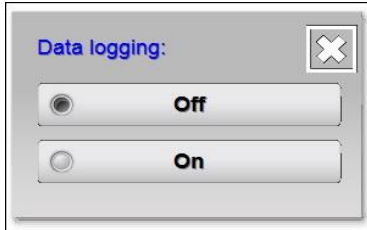

In the screen the current value of the parameter is indicated by a  (Select). Press one of the other possible settings to change the parameter and return to the parameter screen.



Press  (Cancel) to not change the parameter and to return to the parameter screen.

6.13 Overview of HMI parameters

The HMI has the following parameters and settings (Depending on the selected user level, more or fewer parameters and settings may be visible).

Parameter name	Values	Description
Device name		HMI name to be entered by the user. This allows the HMI to be given a name that is recognisable to all users.
Machine position/name		User-defined name to indicate where the HMI is located in the machine.
Device type	IQ Easy Manager	Manager IQ Easy
Data logging	Off	The data logging is disabled for the system logging.
	On	The data logging is enabled for the system logging.
Logfile refresh time	1 min	For all connected Devices, the measured values are stored in a log file every specified time interval. See also parameter " Log Sensor Peaks on Remotel/O ".
	5 min	
	15 min	
	30 min	
	60 min	
Language	Duits	Language in which the information is presented on the screen.
	Engels	
	Frans	
	Italiaans	
	Nederlands	
	Pools	
	Spaans	
	Tsjechisch	
Zweeds		
Date/time		Local time.
Date format	DD-MM-YYYY	Dutch date format.
	YYYY/MM/DD	American date format.
	DD.MM.YYYY	German date format.
Realtime screen refresh	Off	The HMI screen is only refreshed if changes are detected. This setting is intended for slower system controls.
	1 s	The HMI screen is refreshed every set time interval, regardless of whether there have been changes or not. These settings are intended for fast system controls.
	2 s	
	3 s	
	4 s	
5 s		
Standby/Run access level	Basic	Set the minimum user level of users who can set the Machine and/or Devices to the Operation Mode (Standby/Run).
	Advanced	
	Expert	
Advanced password		Setting the password with which an " Advanced " user can access the system.
Expert password		Setting the password with which an " Expert " user can access the system.
Remote FTP username		Username to be entered for the FTP server.
Remote FTP password		Password to be entered for the FTP server.

Ethernet IP address	0.0.0.0	Display of the IP address assigned to the Manager IQ Easy. The FTP server can be used via this IP address to access the log files of the Manager IQ Easy via the network.
Buzzer	Off	Touching the screen surfaces does not produce an acoustic signal.
	On	When touching a screen with which a next action is started, a short sound signal is given.
Buzzer frequency	2000 Hz	The pitch of the audio signal.
Buzzer beep length	70 ms	The length of the audio signal.
Software version		Identification of the current software version of the HMI.
Device serial number	0	Serial number on the Manager IQ Easy.
Check configuration	No	No check is made on the correctness of the active configuration.
	Yes	It is checked whether the current configuration of the system matches the saved configuration. An error is given in the event of deviations.
Invalid shutdown popup time	Off	After the Manager IQ Easy has been shut down incorrectly, a pop-up window with the text " Invalid shutdown " will appear after restarting. This parameter determines the amount of time after which the pop-up window is automatically closed. Off = the screen will remain until the user pushes it away.
	5 min	After incorrectly closing and restarting the Manager IQ Easy, the pop-up window with the warning " Invalid Shutdown " will remain on the screen for the indicated time. The user can also push the screen away earlier by pressing " OK " to push.
	10 min	
	15 min	
	30 min	
Rescan Ext.Box timer	30 s	Time interval that determines the number of seconds after which a Backplane or Extension IQ Easy is searched for. If this parameter is set to " 0s ", the only way to search for newly connected Extension IQ Easy units is to use the Action " Scan Ext. Boxes ".
Popup on disconnected BP	No	If communication with the Backplane is lost, a pop-up screen will not be displayed.
	Yes	If communication with the Backplane is lost, a pop-up window with this warning will be displayed.

Popup on disconnected ExtBox	No	If communication with an Extension IQ Easy is lost, no pop-up will be displayed.
	Yes	If communication with an Extension IQ Easy is lost, a pop-up will be displayed with this warning.
Popup on disconnected Device	No	If communication with a Device is lost, no pop-up will be displayed.
	Yes	If communication with a Device Backplane is lost, a pop-up will be displayed with this warning.
Autoclose reconnected dev.	No	The pop-up screen with the warning that communication with the Device has been lost will not close automatically once communication with the Device has been restored.
	Yes	The pop-up screen with the warning that communication with the Device has been lost will close automatically once communication with the Device has been restored.
HMI bus communication timeout	90 s	This general system setting is used by Devices to be able to detect whether the communication between the Device and the Manager IQ Easy has been broken. If this is the case, the Device will give an alarm as soon as communication with the Manager IQ Easy has been established again.
Run state display colour green	No	For Standby the colour green is used on the screen and for Run the colour blue (see also Section 6.5.1, 6.7 and 6.17.10).
	Yes	For Standby the colour blue is used on the screen, and for Run the colour green (see also Section 6.5.1, 6.7 and 6.17.10).
HiSpeed Remotel/O	On	This value is set to “ On ” by default.
Log Sensor Peaks on Remotel/O	Off	The measured sensor peak values are stored with a fixed time interval (see parameter “ Log file refresh time ”).
	On	The measured sensor peak values are stored using the Remotel/O input.

6.14 Overview of Backplane / ExtensionBox parameters

The Backplane and Extension IQ Easy units have the following parameters and settings (Depending on the selected user level, more or fewer parameters and settings may be visible).

Parameter name	Values	Description
Device name		Name of the Backplane or Extension IQ Easy entered by the user. This is to give the Backplane or Extension IQ Easy a name that is recognisable to all users.
Device type	IQ Easy Backplane	IQ Easy Backplane.
Anybus Network Type (*)	EtherNet/IP(TM)	Type identification of the installed Fieldbus module.
	PROFINET IRT	
	PROFINET IRT IIoT	
Anybus Version (*)		Version of the installed Fieldbus module.
Anybus Serial No (*)		Serial number of the installed Fieldbus module.
Fieldbus Config (*)		Code of the loaded software configuration which is supported by the Fieldbus.
Use DHCP (*)	No	The Fieldbus module does not use a DHCP server and the network settings will have to be set by the user.
	Yes	The Fieldbus module uses a DHCP server and the network settings are set by the DHCP server.
DNS1 (*)	0.0.0.0	The address of the DNS server.
DNS2 (*)	0.0.0.0	Alternative address of the DNS server.
IP Address (*)	0.0.0.0	IP address of the Fieldbus module.
IP Subnet Mask (*)	0.0.0.0	Subnet mask of the Fieldbus module.
IP Gateway (*)	0.0.0.0	IP of the Gateway of the Fieldbus module.
Domain name (*)		Domain name used for the network in which the Fieldbus module is active.
Host name (*)		Used Host name of the Fieldbus module to identify it in the network.
Fieldbus BusState (*)	0x00	Feedback of the status of the Fieldbus module. Code 0x00 is the Setup phase.
	0x01	Initialisation phase.
	0x02	Wait Process, a connection with the PLC or remote IO application is awaited.
	0x03	Idle.
	0x04	Process Active, the connection with the PLC or remote IO application is active.
	0x05	Error.
	0x07	Exception.

Fieldbus BusError (*)	0x00	Error code if there are problems with the Fieldbus module or the network. The code 0x00 indicates that there is no error or fault; every other value indicates that a problem was found during the initialisation of the Fieldbus module. Contact your Simco-Ion to solve this problem.
Fieldbus Control (*)	0x00	Feedback of the Fieldbus ' Control ' command. This command is controlled via the PLC to control Devices in Standby and Run, for example. See the relevant Fieldbus documentation for explanation regarding this parameter.
Fieldbus DevRunMode (*)	0x00000000	Feedback of the Fieldbus ' DevRunMode ' command. This command is controlled via the PLC to be able to control Devices separately in Stand-by and Run. See the relevant Fieldbus documentation for explanation regarding this parameter.
Fieldbus Sensor ports (*)	0	This parameter is used to map the Sensor Devices present in the system onto the fieldbus data structure. See also 6.31.5.
Fieldbus PerfIQ ports (*)	0	This parameter is used to map the Performax IQ Easy Devices present in the system onto the fieldbus data structure. See also 6.31.5.
Fieldbus PerfIQ-Ex ports (*)	0	This parameter is used to map the Performax IQ Easy Ex Devices present in the system onto the fieldbus data structure. See also 6.31.5.
Fieldbus TH2 ports (*)	0	This parameter is used to map the Thunderlon2 Devices present in the system onto the fieldbus data structure. See also 6.31.5.
Fieldbus CMM ports (*)	0	This parameter is used to map the CMM Easy Devices present in the system onto the fieldbus data structure. See also 6.31.5.
Fieldbus CM-Tiny ports (*)	0	This parameter is used to map the CM-Tiny Devices present in the system onto the fieldbus data structure. See also 6.31.5.
Fieldbus GenConv ports (*)	0	This parameter is used to map the IQ-Com Generator Convertor Devices present in the system onto the fieldbus data structure. See also 6.31.5.
Device timeout	5 s	Set time before a Device is reported as Disconnected if communication with the Device is lost. Please note: If a value of 0 seconds is set, it will not be detected that a Device is no longer communicating with the system. This will cause undesired behaviour of the system. The '0 second' setting is only intended for testing purposes of Simco Service Engineers.

Toggle RS485 AB	Off	The signals on the Device communication port are not switched.
	On	The signals on the Device communication port are switched. Enable this parameter if older Performax IQ and/or Sensors are used in the system. The parameter can also be switched on if a mistake is made during the wiring, as a result of which Devices are not detected by the HMI.
Autorun	Yes	For a Backplane and Extension IQ Easy, this parameter will always be set to Yes. The Backplane and Extension IQ Easy units will always be started.
Firmware version		Identification of the current firmware version of the Backplane or Extension IQ Easy.
Port5 Mode	Serial	The Device port is set and suitable for communicating with IQ Easy Devices.
	Analog I/O	The Device port is set to communicate with Non-IQ Easy Devices.
Port6 Mode	Serial	The Device port is set and suitable for communicating with IQ Easy Devices.
	Analog I/O	The Device port is set to communicate with Non-IQ Easy Devices.
OE/OC Mode	OE-Mode	The digital Remote I/O outputs (" All system functions OK ", " Global Alarm " and " Global Warning ") are used as Open Emitter. See also Section 5.4.4.1.
	OC-Mode	The digital Remote I/O outputs (" All system functions OK ", " Global Alarm " and " Global Warning ") are used as Open Collector. See also Article 5.4.4.1.
SysOk output active low	No	The " All system functions OK " on the Remote I/O output is used as an "Active High" signal. See also Article 5.4.4.1.
	Yes	The " All system functions OK " on the Remote I/O output is used as an "Active Low" signal. See also Article 5.4.4.1.
Alarm output active low	No	The " Global Alarm " on the Remote I/O output is used as "Active High" signal. See also Article 5.4.4.1.
	Yes	The " Global Alarm " on the Remote I/O output is used as "Active Low" signal. See also Article 5.4.4.1.
Warning output active low	No	The " Global Warning " on the Remote I/O output is used as "Active High" signal. See also Article 5.4.4.1.
	Yes	The " Global Warning " on the Remote I/O output is used as "Active Low" signal. See also Article 5.4.4.1.
Remote IN	Off	Feedback from the " Remote On/Off " signal from the Remote I/O connector. Can be used for testing purposes. See also Article 5.4.4.2.
	On	
Fieldbus IN (*)	Off	Feedback from the " Remote On/Off " control of the Fieldbus protocol. Can be used for testing purposes.
	On	

(*): This parameter is only available in (Fieldbus) versions of the Backplane.

6.15 Overview of common Device parameters

Some common parameters will be described here. The specific parameters of the different Devices will be described in the manuals of the Devices.

Parameter name	Values	Description
Device name		Device name to be entered by the user. This is to give the Device a name that is recognisable to all users.
Machine position/name		User-defined name to indicate where the HMI is located in the machine.
Device type	CMM IQ Easy CM Tiny IQ IQ Com Gen. Conv. Performax IQ Easy Performax IQ Ex Sensor IQ Easy Thunderlon2	Device type name.
Device type version	Distance Hybrid IQ Speed	This setting indicates which subversion of the Device is operational. See the manuals of the different Devices for more information.
Operation mode	Fixed AutoTune Manual CLFB	The Device functions in a predefined mode. The user cannot influence the high voltage supplied by the Device. It is currently unavailable. The Device functions in manual mode. The user can set the high voltage supplied by the Device. Close Loop Feedback mode, the bar must be paired with a sensor to be able to control the delivered high voltage.
Last calibration date		Date and timestamp indicating when the last bar calibration was performed.
Paired device		Pair the sensor with the selected bar. With this, the CLFB functionality can be used in the bar, with which the required high voltage can be determined on the basis of the high voltage measured by the sensor.
Paired devices		Pair the sensor with the selected bars (maximum 4 pieces). With this, the CLFB functionality can be used in the bars, with which the required high voltage can be determined on the basis of the high voltage measured by the sensor.
Paired sensor		Connect the bar with the selected sensor. With this, the CLFB functionality can be used in the bar, with which the required high voltage can be determined on the basis of the high voltage measured by the sensor.

Last warning		Date and timestamp indicating when the last Warning was registered.
Last alarm		Date and timestamp indicating when the last Alarm was registered.
Data logging	Off	The data logging (measured values) for the Device is disabled.
	On	The data logging (measured values) for the Device is enabled.
Autorun	No	After giving a Global Run, the Device will not go into Running mode. The Device can only be set to Running via a Device Run.
	Yes	After giving a Global Run, the Device will go into Running mode.
Graphic refresh time	0.5 s	Time interval with which the speed at which the graphic screen is refreshed is also set. See also Article 6.11.2.
	1 s	
	5 s	
	10 s	
	1 min	
	10 min	
Remote on/off source	Continuous	In Running mode, charging and discharging bars provide continuous high voltage. With a sensor rod, the measuring elements will always be active.
	Input	In Running mode, the charging and discharging bars only provide high voltage when the external Remote On/Off input is active.
	Fieldbus (*)	In Running mode, the charging and discharging bars only provide high voltage when the Fieldbus Remote On/Off control is active.
Firmware version		Identification of the current firmware version of the Device.
Device serial number		Device serial number.

(*): This parameter is only available if the Fieldbus versions of the Backplane are used.

6.16 Switching off the Manager IQ Easy

If necessary, go to the main screen  (Home).

Press  (Userlevel).



The following screen will open.



Press **“Save data & shutdown”**.



A blue screen appears with the text **“IQ EASY IS READY TO SHUTDOWN”**.



Now turn off the Manager IQ Easy by turning off the mains power button.

 **Note:**

- **Uncontrolled or incorrect switching off of the Manager IQ Easy can lead to corrupt data files and/or a corrupt file system. As a result, the Manager IQ Easy will start to function unreliably or will no longer log any information. Log files will therefore be incomplete and valuable information will be lost. If a pop-up screen with the warning “Invalid shutdown” is displayed after starting the Manager IQ Easy, this means that the Manager IQ Easy has been switched off in an uncontrolled or incorrect way.**

The Manager IQ Easy HMI can be restarted instead of being switched off by pressing the “**Restart**” button to push.

6.17 Changing some commonly used parameters

In the following section, some frequently used parameters will be adjusted based on examples. A few more difficult to understand parameters or settings will also be explained.



6.17.1 Setting the user language of the HMI (Expert user)

To set the language of the HMI, the user must be logged in as Expert (see Section 6.8).

If necessary, go to the main screen  (Home).

If necessary, log in as  (User level, Expert), see Section 6.9.

Press  (Info). The (Information) screen of the HMI will now open.

Browse using the  and  buttons to the page with parameter “**Language**” (You can also use the large non-visible areas to browse).

Click  (EditMode) to change the parameter.

Press  (Edit) after the “**Language**” parameter. The following screen will be opened.



Select the desired language. The screen will now close.

Press  (Home) to return to the main screen and log in again as a Basic user (see Section 6.9).

Note:

- If the Service user level is selected, the HMI will use the English display again. By selecting one of the other user levels again, the set language will be used again.



6.17.2 Setting the system time (Expert user)

To set the clock of the HMI, the user must be logged in as Expert (see Section 6.8).

If necessary, go to the main screen  (Home).

If necessary, log in as  (User level, Expert), see Section 6.9.



Press  (Info). The (Information) screen of the HMI will now open.

Browse using the  and  buttons to the page with the parameter “**Date/time**” (You can also use the large non-visible areas to browse).

Click  (EditMode) to change the parameter.

Press  (Edit) after the “**Date/time**” parameter. The following screen will be opened.



Use the  and  buttons to set the date and time correctly.

Press  (Accept) to save the newly set date and time.

Press  (Home) to return to the main screen and log in again as a Basic user (see Section 6.9).

Note:

- The IQ Easy system does not switch between summer and winter time. You must set the clock yourself.



6.17.3 Setting the date display ((Expert user))

The date can be displayed on the screen in different ways (Dutch, American and German formats). To adjust this setting, the user must be logged in as Expert (see Section 6.8).

If necessary, go to the main screen  (Home).

If necessary, log in as  (User level, Expert), see Section 6.9.

Press  (Info). The (Information) screen of the HMI will now open.

Browse using the  and  buttons to the page with the parameter “**Date format**” (You can also use the large non-visible areas to browse).

Click  (EditMode) to change the parameter.

Press  (Edit) after the “**Date format**” parameter. The following screen will be opened.

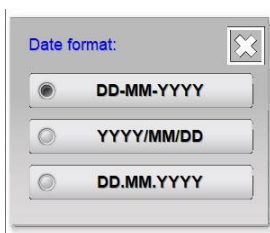

Select the desired display format. The screen will now close.



Press  (Home) to return to the main screen and log in again as a Basic user (see Section 6.9).

6.17.4 Setting a password for the 'Advanced user' user level

If necessary, go to the main screen  (Home).

If necessary, log in as  or  (Userlevel, Advanced/Expert), see Section 6.9.



Press  (Info). The (Information) screen of the HMI will now open.

Browse using the  and  buttons to the page with parameter "**Advanced password**" (You can also use the large non-visible areas to browse).

Click  (EditMode) to change the parameter.

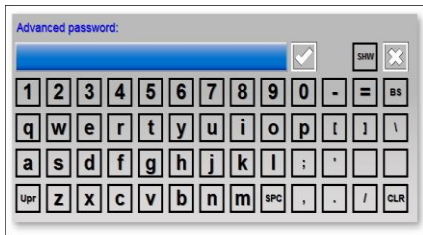
Press  (Edit) after the "**Advanced password**" parameter. A keyboard will now become active.





Enter the (new or current) password. The password can be made visible while typing by pressing  (Show). Press  (Hide) to hide the password again.

Press  (Accept) to save the password.



Press  (Home) to return to the main screen and log in again as a Basic user (see Section 6.9).

6.17.5 Setting a password for the 'Expert user' user level

If necessary, go to the main screen  (Home).

If necessary, log in as  (User level, Expert), see Section 6.9.



Press  (Info). The (Information) screen of the HMI will now open.

Browse using the  and  buttons to the page with parameter “**Expert password**” (You can also use the large non-visible areas to browse).

Click  (EditMode) to change the parameter.

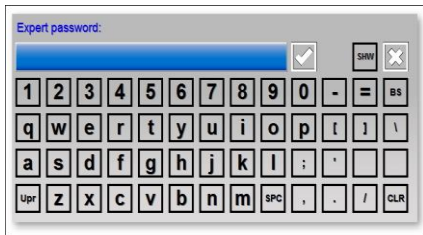
Press  (Edit) after the “**Expert password**” parameter. A keyboard will now become active.



Enter the (new or current) password. The password can be made visible while typing by pressing  (Show). Press  (Hide) to hide the password again.

Press  (Accept) to save the password.

Press  (Home) to return to the main screen and log in again as a Basic user (see Section 6.9).



6.17.6 Resetting the Advanced user password (Expert user)

To change the Advanced user password, a higher user level (Expert or higher) must be logged in.

If necessary, go to the main screen  (Home).

If necessary, log in as  (User level, Expert), see Section 6.9.



Press  (Info). The (Information) screen of the HMI will now open.

Browse using the  and  buttons to the page with parameter “**Advanced password**” (You can also use the large non-visible areas to browse).

Click  (EditMode) to change the parameter.

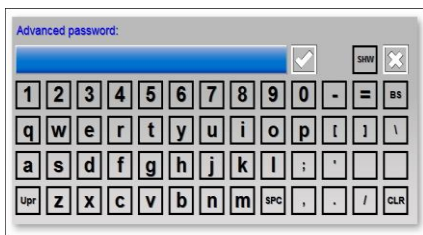
Press  (Edit) after the “**Advanced password**” parameter. A keyboard will now become active.



Enter the new password for the Advanced user. The password can be made visible while typing by pressing  (Show). Press  (Hide) to hide the password again. If a password has already been entered, the  (Show) button can also be used to view the password.

Press  (Accept) to save the password.

Press  (Home) to return to the main screen and log in again as a Basic user (see Section 6.9).

6.17.6 Resetting the Expert user password (Expert user)



To change the Expert user password, you must log in with a special Service code.

If necessary, go to the main screen  (Home).

Press ,  or  (User Level).

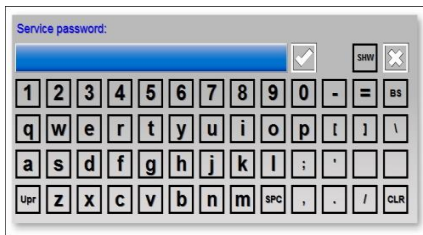
Select “**Service**”. A keyboard will now appear.



Enter the code “**288333**”. The special access code can be made visible while typing by pressing  (Show). Press  (Hide) to hide the special access code again.

Press  (Accept) to reset the Expert password.

Press  (Home) to return to the main screen and log in again as a Basic user (see Section 6.9) or login as an Expert user and enter a new Expert password (see Section 6.17.5).



6.17.8 Users Standby/Run control level (Expert user)

The IQ Easy Manager has the option to block (Basic users) and/or (Advanced users) from putting Devices in Standby/Running mode. The level of users who can put Devices in Standby/Running mode is set as follows (the user must log in as an Expert user, see Section 6.8).

If necessary, go to the main screen  (Home).

If necessary, log in as  (User level, Expert), see Section 6.9.

Press  (Info). The (Information) screen of the HMI will now open.

Browse using the  and  buttons to the page with the parameter “**Standby/Run access level**” (You can also use the large non-visible areas to browse).

Click  (EditMode) to change the parameter.

Press  (Edit) after the “**Standby/Run access level**” parameter.

The following screen will be opened.



Select the desired user level that may have access to the Standby/Running Device buttons. The screen will now close.

Press  (Home) to return to the main screen and log in again as a Basic user (see Section 6.9).



6.17.9 Setting Logging of Sensor Peak values (Expert user)

There are 2 ways in which the measured peak measurement values of a Sensor Device can be stored in the log file. By default, this will be saved using a fixed time interval. However, it is also possible to choose to have these measured values stored on a Remote On → Off input change. This choice is set via the “**Log Sensor Peaks on Remote I/O**” parameter.

If necessary, go to the main screen  (Home).

If necessary, log in as  (User level, Expert), see Section 6.9.

Press  (Info). The (Information) screen of the HMI will now open.

Browse using the  and  buttons to the page with parameter “**Log Sensor Peaks on Remote I/O**” (You can also use the large non-visible areas to browse).

Click  (EditMode) to change the parameter.

Press  (Edit) after the “**Log Sensor Peaks on Remote I/O**” parameter.

The following screen will be opened.

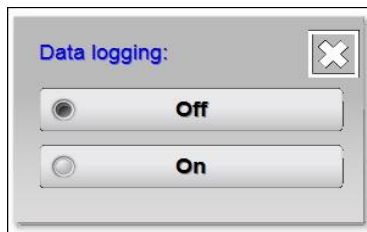

Select “**Off**” if the measured Sensor Peak values are to be saved every set time interval (see also parameter “**Log file refresh time**”).

Select “**On**” if the measured Sensor Peak values must be stored with each Remote On/Off flank change.

Note:

- The Device parameter “**Data logging**” must be set to “**On**” to save the measured Sensor Peak values in the log file.

The screen will now close.

Press  (Home) to return to the main screen and log in again as a Basic user (see Section 6.9).



6.17.10 Setting the Run state display colour green (Expert user)

As explained in Section 6.5.1 and 6.7, the Manager IQ Easy has 2 modes on which the Standby and Running status colours can be displayed.

If necessary, go to the main screen  (Home).

If necessary, log in as  (User level, Expert), see Section 6.9.

Press  (Info). The (Information) screen of the HMI will now open.

Browse using the  and  buttons to the page with the parameter “**Run state display colour green**” (You can also use the large non-visible areas to browse).

Click  (EditMode) to change the parameter.

Press  (Edit) after the “**Run state display colour green**” parameter.

The following screen will be opened.



Select “**No**” to display the status colour for Standby as green and Running as blue.

Select “**Yes**” to display the status colour for Standby as blue and Running as green.

The screen will now close.

Press  (Home) to return to the main screen and log in again as a Basic user (see Section 6.9).



6.17.11 Reading network IP address (Expert user)

To connect to the FTP server via a network, the user must know which IP address the Manager IQ Easy has been assigned. This IP address can be read as follows. (The user must be logged in as an Expert user, see Section 6.8)

If necessary, go to the main screen  (Home).

If necessary, log in as  (User level, Expert), see Section 6.9.

Press  (Info). The (Information) screen of the HMI will now open.

Browse using the  and  buttons to the page with parameter “**Ethernet IP address**” (You can also use the large non-visible areas to browse).

The IP address specified in this setting can be used in an FTP client to connect to the Manager IQ Easy via the network (see Section 06:22).

Press  (Home) to return to the main screen and log in again as a Basic user (see Section 6.9).

6.18 Linking and disconnecting Devices (Expert user)



The IQ Easy system has the option to connect bars and sensors. This allows them to exchange measurement and control data with each other, so that a control loop can be built in order to suppress static electricity in a controlled manner.

6.18.1 Linking a member with a Sensor Device (Expert user)



To link 2 or more Devices together, you must at least be logged in as an Expert user (see Section 6.8).

If necessary, go to the main screen  (Home).

If necessary, log in as  (User level, Expert), see Section 6.9.

Press  or  (Device) of the Device to be connected.

If necessary, press  (Information) to go to the Information screen.

Browse using the  and  buttons to the page with parameter “**Paired sensor**” (You can also use the large non-visible areas to browse).

Click  (EditMode) to change the parameter.

Press  (Edit) after the “**Paired sensor**” parameter. A screen will open that looks like this.

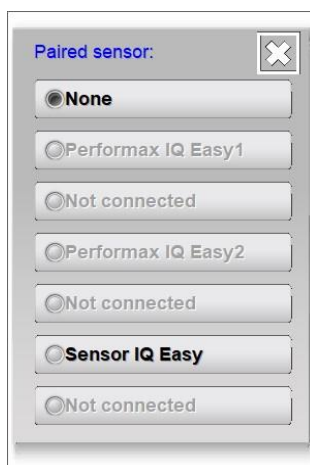

If necessary, browse using the  and  buttons to the page with the Sensor Device to which the bar is to be linked.

Now press the button for the Sensor Device to be paired.



The selection screen will close and the parameter and settings screen will be displayed with the adjustment made.

Press  (Home) to return to the main screen and log in again as a Basic user (see Section 6.9).

 **Note:**

- The Manager IQ Easy will attempt to establish the link in the Sensor Devices automatically. It is good to check in the Sensor Devices whether this has actually been achieved. If it did not go well, the link in the Sensor Devices will then have to be made manually.

Then check whether the links were also made in the Sensor Devices. This will be described in the following section.

6.18.2 Linking a Sensor Device to a bar (Expert user)



To link 2 or more Devices together, you must at least be logged in as an Expert user (see Section 6.8).

If necessary, go to the main screen  (Home).

If necessary, log in as  (User level, Expert), see Section 6.9.

Press  (Device) of the Device to be connected.

If necessary, press  (Information) to go to the Information screen.

Browse using the  and  buttons to the page with parameter “**Paired device**” or “**Paired devices**” (This depends on the support capabilities of the Device. It is also possible to use the large non-visible areas to browse.)

Click  (EditMode) to change the parameter.

Press  (Edit) after the “**Paired device**” or “**Paired devices**” parameter. A screen will open that looks like this.



Select button “**None**” to add a new Device, or select one of the Devices already assigned to change it.



The following screen will be opened.

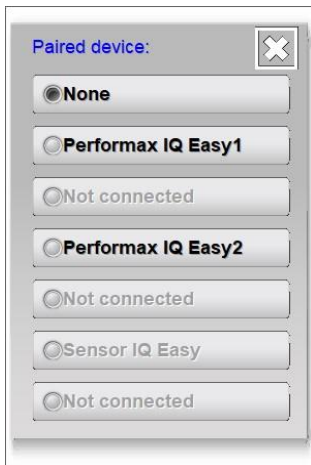

If necessary, browse using the  and  buttons to the page with the Device to which the sensor is to be linked.

Now press the button for Device to be paired.

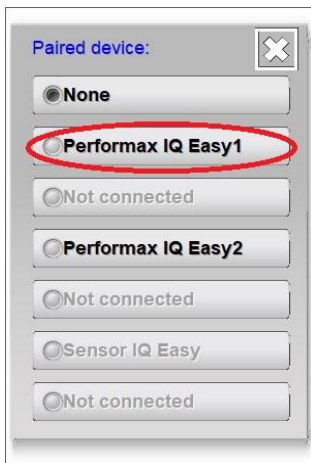

The screen will close and the screen will now show the linked Device in the list.



Depending on the software version, only 1 Sensor Device can be link with 1 bar; with other software versions, linking up to 4 bars is supported. Repeat the steps described above to link a 2nd or next Device to the Sensor Device.



Press  (Accept) to complete the pairing of the Devices and to save the created pairings.



Press  (Home) to return to the main screen and log in again as a Basic user (see Section 6.9).



Note:

- The Manager IQ Easy will attempt to establish the link in the Devices automatically. It is good to check in the Devices whether this has actually been achieved. If it did not go well, the link in the Devices will then have to be made manually.

Then check whether the links were also made in the Devices. This has been described in the previous section.

6.18.3 Activating the CLFB voltage control (Expert user)



If the Sensor Devices and Bar Devices are linked to each other, the CLFB control can be activated. For this, the user must be logged in as an Expert (see Section 6.8).

If necessary, go to the main screen  (Home).

If necessary, log in as  (User level, Expert), see Section 6.9.

Press  or  (Device) of the Device whose CLFB mode must be activated.

If necessary, press  (Information) to go to the Information screen.

Browse using the  and  buttons to the page with parameter “**Operation mode**” (You can also use the large non-visible areas to browse).

Click  (EditMode) to change the parameter.

Press  (Edit) after the “**Operation mode**” parameter. A screen will open that looks like this.

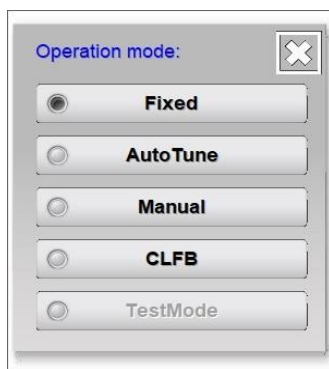

Now press “**CLFB**”.

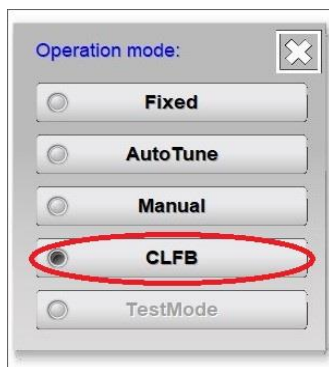

The screen will close and the CLFB control has been established.





Press  (Home) to return to the main screen and log in again as a Basic user (see Section 6.9).

6.18.4 Disconnecting a coupled bar from the Sensor Device (Expert user)



To be able to disconnect linked Devices, you must at least become an Expert user (see Section 6.8).

If necessary, go to the main screen  (Home).

If necessary, log in as  (User level, Expert), see Section 6.9.

Press  or  (Device) of the Device to be paired.

If necessary, press  (Information) to go to the Information screen.

Browse using the  and  buttons to the page with parameter “**Paired sensor**” (You can also use the large non-visible areas to browse).

Click  (EditMode) to change the parameter.

Press  (Edit) after the “**Paired sensor**” parameter. A screen will open that looks like this.

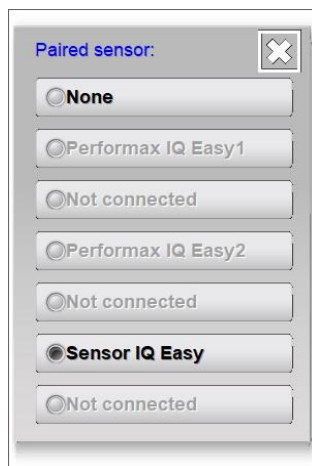

Press “**None**”.

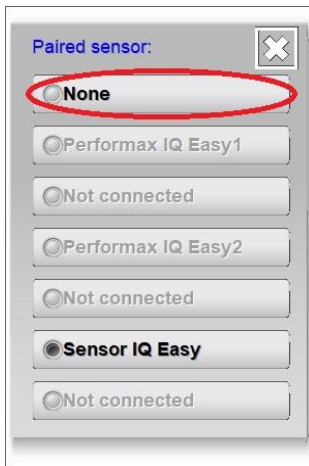

The selection screen will close and the parameter and settings screen will be displayed with the adjustment made.



Press  (Home) to return to the main screen and log in again as a Basic user (see Section 6.9).



Note:

- The Manager IQ Easy will attempt to automatically break off the unpairing of the Sensor Devices. It is good to check in the Sensor Devices whether this has actually been achieved. If it did not go well, the unpairing in the Sensor Devices will then have to be interrupted manually.

Then check whether the link has been broken in the Sensor Devices. This will be described in the following section.

6.18.5 Disconnecting a Sensor Device from a bar (Expert user)



To be able to disconnect linked Devices, you must at least become an Expert user (see Section 6.8).

If necessary, go to the main screen  (Home).

If necessary, log in as  (User level, Expert), see Section 6.9.

Press  (Device) of the Device to be disconnected.

If necessary, press  (Information) to go to the Information screen.

Browse using the  and  buttons to the page with parameter “**Paired device**” or “**Paired devices**” (This depends on the support capabilities of the Device. It is also possible to use the large non-visible areas to browse.)

Click  (EditMode) to change the parameter.

Press  (Edit) after the “**Paired device**” or “**Paired devices**” parameter. A screen will open that looks like this.

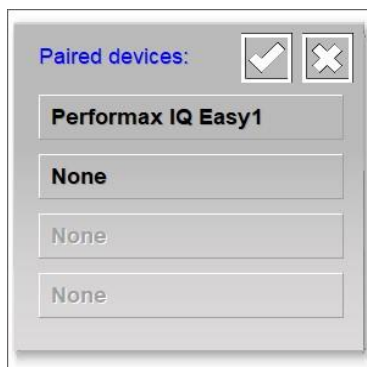

Select the button of the Device to be disconnected (In the example, “**Performax IQ Easy 1**” is selected).

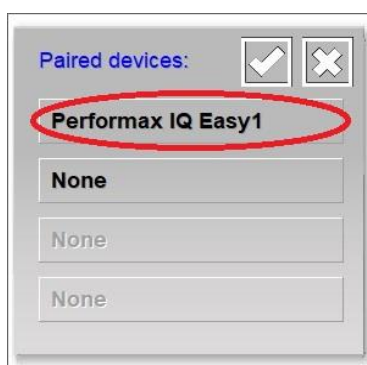

The following screen will be opened.

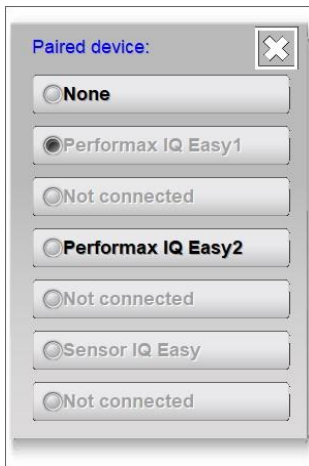

Press **"None"**.



The screen will close and the disconnected Device will be removed in the screen.



Depending on the software version, only 1 Sensor Device can be link with 1 bar; with other software versions, linking up to 4 bars is supported. Repeat the steps described above to unlink a 2nd or next Device from the Sensor Device.

Press  (Accept) to complete the unpairing of the Devices and to save the created pairings.

Press  (Home) to return to the main screen and log in again as a Basic user (see Section 6.9).

 **Note:**

- The Manager IQ Easy will attempt to automatically break off the unpairing of the Devices. It is good to check in the Devices whether this has actually been achieved. If it did not go well, the link in the Devices will then have to be broken manually.



Then check whether the disconnections were also broken in the Devices. This has been described in the previous section.

6.18.6 Disconnecting a Device from a deleted Sensor Device (Expert user)



To be able to disconnect linked Devices, you must at least become an Expert user (see Section 6.8).

If necessary, go to the main screen  (Home).

If necessary, log in as  (User level, Expert), see Section 6.9.

Press  or  (Device) of the Device to be paired.

If necessary, press  (Information) to go to the Information screen.

Browse using the  and  buttons to the page with parameter “**Paired sensor**” (You can also use the large non-visible areas to browse).

Click  (EditMode) to change the parameter.

Press  (Edit) after the “**Paired sensor**” parameter. A screen will open that looks like this.

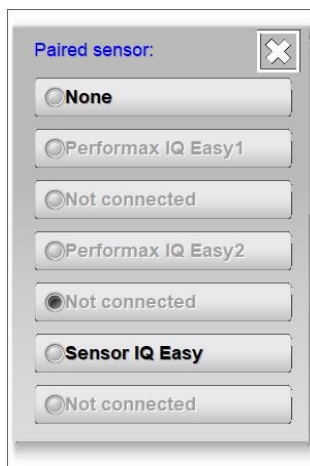

Press “**None**”.

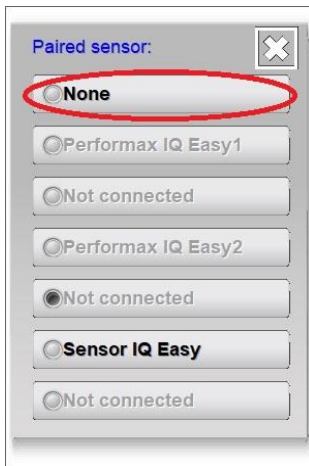



The selection screen will close and the parameter and settings screen will be displayed with the adjustment made.

Press  (Home) to return to the main screen and log in again as a Basic user (see Section 6.9).

6.18.5 Disconnecting a Sensor Device from a deleted bar (Expert user)



To be able to disconnect linked Devices, you must at least become an Expert user (see Section 6.8).

If necessary, go to the main screen  (Home).

If necessary, log in as  (User level, Expert), see Section 6.9.

Press  (Device) of the Device to be disconnected.

If necessary, press  (Information) to go to the Information screen.

Browse using the  and  buttons to the page with parameter “**Paired device**” or “**Paired devices**” (This depends on the support capabilities of the Device. It is also possible to use the large non-visible areas to browse.)

Click  (EditMode) to change the parameter.

Press  (Edit) after the “**Paired device**” or “**Paired devices**” parameter. A screen will open that looks like this.



Select the button “**Not connected**” of the Device to be disconnected.

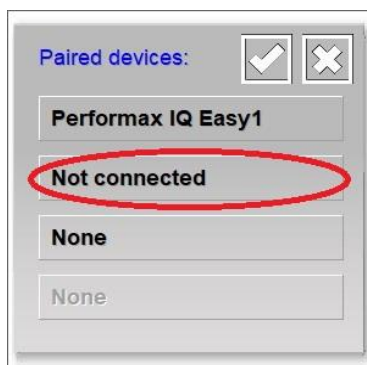

The following screen will be opened.

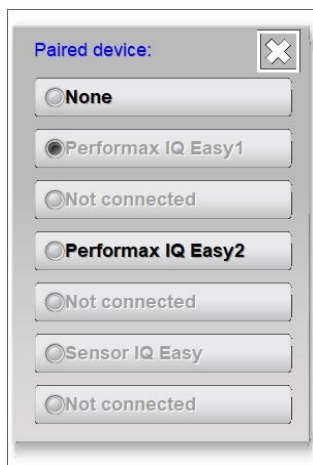

Press **“None”**.

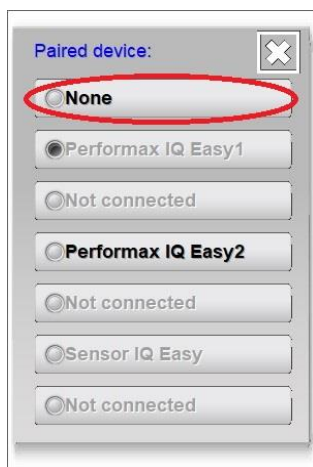

The screen will close and the disconnected Device will be removed from the list.

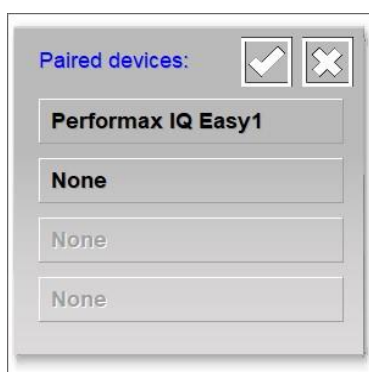

Depending on the software version, only 1 Sensor Device can be link with 1 bar; with other software versions, linking up to 4 bars is supported. Repeat the steps described above to unlink a 2nd or next Device from the Sensor Device.

Press  (Accept) to complete the unpairing of the Devices and to save the created pairings.

Press  (Home) to return to the main screen and log in again as a Basic user (see Section 6.9).

6.19 Activating and deactivating sensor segments (Expert user, Sensor version V5_2 only)

6.19.1 Activating and deactivating sensor segments via the settings screen (Expert user)



Up to 16 segments can be placed in a Sensor Device (version V5_2). Because in a Sensor Device a Sensor Segment does not actually have to be placed at every position, positions where no Sensor Segment has been placed can be switched off. Sensor Segments can also be temporarily disabled. For this, the user must be logged in as an Expert (see Section 6.8).

If necessary, go to the main screen  (Home).

If necessary, log in as  (User level, Expert), see Section 6.9.

Press  (Device) of the Device.

If necessary, press  (Information) to go to the Information screen.

Browse using the  and  buttons to the page with the parameter “**Active segments**” (You can also use the large non-visible areas to browse).

Click  (EditMode) to change the parameter.

Press  (Edit) after the “**Active segments**” parameter. A screen will open that looks like this.

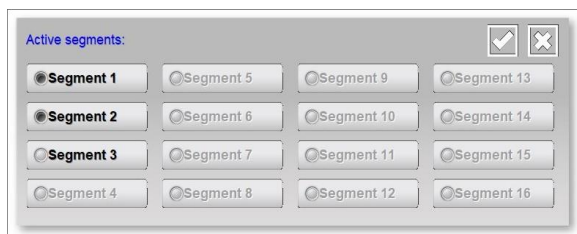

Activate or deactivate the desired segments by pressing the corresponding segment button.

Press  (Accept) to save the changes made.

Press  (Home) to return to the main screen and log in again as a Basic user (see Section 6.9).

6.19.2 Activating and deactivating sensor segments via the Graphics screen (Expert user)

Segments can also be activated and deactivated via the Graphics screen. For this, the user must be logged in as an Expert (see Section 6.8).

If necessary, go to the main screen  (Home).

If necessary, log in as  (User level, Expert), see Section 6.9.

Press  (Device) of the Device.

If necessary, press  (Graphics) to go to the Graphics screen.

Press  (Edit) to open the “**Active segments**” screen.

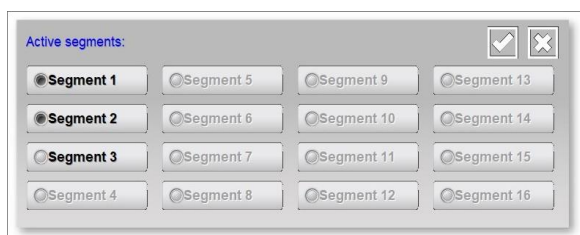

Activate or deactivate the desired segments by pressing the corresponding segment button.

Press  (Accept) to save the changes made.

Press  (Home) to return to the main screen and log in again as a Basic user (see Section 6.9).

6.20 Enabling and disabling Sensor segments (Expert user)

6.20.1 Enabling and disabling Sensor segments via the settings screen (Expert user)



Up to 16 segments can be placed in a Sensor Device. Depending on, for example, the width of the Web, Sensor Segments can be temporarily disabled. To enable and disable Sensor segments, the user must be logged in as Expert (see Section 6.8).

If necessary, go to the main screen  (Home).

If necessary, log in as  (User level, Expert), see Section 6.9.

Press  (Device) of the Device.

If necessary, press  (Information) to go to the Information screen.

Browse using the  and  buttons to the page with the parameter “**Enabled segments**” (You can also use the large non-visible areas to browse).

Click  (EditMode) to change the parameter.

Press  (Edit) after the “**Enabled segments**” parameter. A screen will open that looks like this.

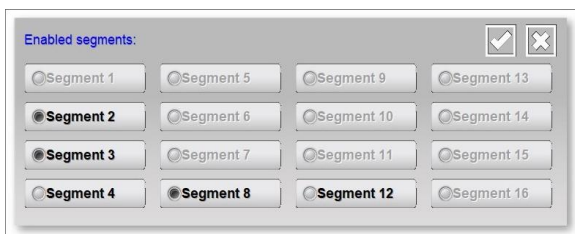

Enable or disable the desired segments by pressing the corresponding segment button.

Press  (Accept) to save the changes made.

Press  (Home) to return to the main screen and log in again as a Basic user (see Section 6.9).

6.20.2 Enabling and disabling Sensor segments via the Graphics screen (Expert user)

Segments can also be enabled and disabled via the Graphics screen. For this, the user must be logged in as an Expert (see Section 6.8).

If necessary, go to the main screen  (Home).

If necessary, log in as  (User level, Expert), see Section 6.9.

Press  (Device) of the Device.

If necessary, press  (Graphics) to go to the Graphics screen.

Press  (Edit) to open the “**Enabled segments**” screen.

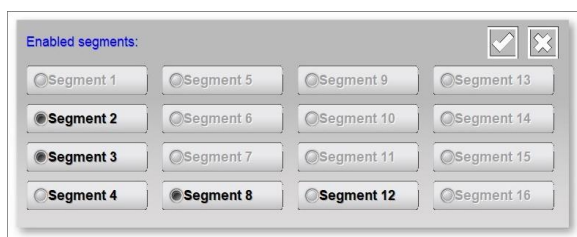

Enable or disable the desired segments by pressing the corresponding segment button.

Press  (Accept) to save the changes made.

Press  (Home) to return to the main screen and log in again as a Basic user (see Section 6.9).

6.20.3 Enabling and disabling Sensor segments via a linked bar (Expert user)



If a bar and a Sensor Device are linked, segments can also be disabled or disabled via the bar. In this case, only calculating measured values is taken into account in the bar, it does not affect the actual settings on the Sensor Device itself.

If necessary, go to the main screen  (Home).

If necessary, log in as  (User level, Expert), see Section 6.9.

Press  or  (Device) of the Device.

If necessary, press  (Information) to go to the (Information) screen.

Browse using the  and  buttons to the page with the parameter “**Enabled segments**” (You can also use the large non-visible areas to browse).

Click  (EditMode) to change the parameter.

Press  (Edit) after the “**Enabled segments**” parameter. A screen will open that looks like this.

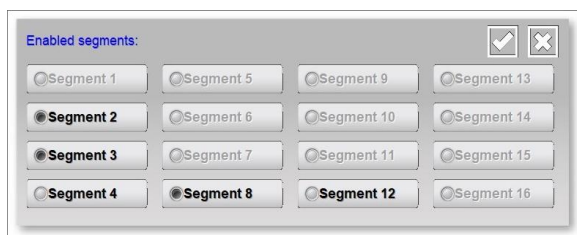

Enable or disable the desired segments by pressing the corresponding segment button.

Press  (Accept) to save the changes made.

Press  (Home) to return to the main screen and log in again as a Basic user (see Section 6.9).

6.21 Checking and monitoring System Configuration (Expert user)

The used System Configuration can be monitored with the IQ Easy system. The Manager IQ Easy checks whether all Devices of the defined System Configuration are present and whether the Devices have the correct Running status. As soon as the active System Configuration does not match the defined System Configuration, an alarm message will appear on the screen with the text “**System configuration not OK!**”.



The alarm message is also stored in the System log with the text “**SYSTEM CONFUGURATION NOT OK**”. Furthermore, the tab  (TabM) is displayed in red.

6.21.1 Switching on the system configuration check for the first time (Expert user)



Note:

- Connect all Devices and put the Devices in the desired Running mode.



If necessary, go to the main screen (Home).



If necessary, log in as (User level, Expert), see Section 6.9.



Press (Info).



Browse using the and buttons to the page with the parameter “**Check last configuration**” (You can also use the large non-visible areas to browse).



Click (EditMode) to change the parameter.



Press (Edit) after the “**Check last configuration**” parameter.



Go back to the main screen (Home).

After a while the following screen will appear.





Press “**YES**”. The screen will close and the active System Configuration will be saved.

Log in again as Basic user (see Section 6.9).

6.21.2 Saving custom system configuration (Expert user)



If the configuration of the IQ Easy system has been changed, it can be saved again as follows.

If necessary, go to the main screen  (Home).

If necessary, log in as  (User level, Expert), see Section 6.9.

Press  (Info).

Press  (Maintenance) to go to the Maintenance screen.

Browse using the  and  buttons to the page with Action “**Save configuration**” (You can also use the large non-visible areas to browse).

Press  (Action) after Action “**Save configuration**”. The following screen will open.



Press “**YES**”. The screen will now close.

Press  (Home) to return to the main screen and log in again as a Basic user (see Section 6.9).

6.21.3 Temporarily/permanently deactivate System Configuration Check (Expert user)

It may be desirable to disable the System Configuration Check (temporarily or otherwise). To do so, set the HMI setting “**Check last configuration**” to “**No**”. See Section 6.12 to access this setting.



Note:

- The last saved System Configuration will be saved on the Manager IQ Easy. When re-enabling the System Configuration Check, the Manager IQ Easy will then also use this configuration.

6.21.4 Re-enabling System Configuration Check (Expert user)

It may be desirable to re-enable the System Configuration Check. To do so, set the HMI setting **“Check last configuration”** to **“Yes”**. See Section 6.12 to access this setting.

 **Note:**



- The last saved System Configuration will be saved on the Manager IQ Easy. When re-enabling the System Configuration Check, the Manager IQ Easy will thus use this configuration. If the configuration has been changed in the meantime, Section 6.21.2 describes how to save the modified configuration.

6.21.5 Temporarily disabling System Configuration Alarm notification (Expert user)

If a deviation has been found in the desired System Configuration, this will be reported to the user via the following pop-up.



Press “**OK**” to close this screen.



The tab  (TabM) will now appear in the main screen in red as an indication that there is a System error. If you wish to temporarily suppress the red tab  (TabM) error notification, perform the following actions.

If necessary, go to the main screen  (Home).

If necessary, log in as  (User level, Expert), see Section 6.9.



Press  (Info).

If necessary, press  (Maintenance) to go to Maintenance screen.

Browse using the  and  buttons to the page with the Action “**Clear system alarm**” (You can also use the large non-visible areas to browse).

Press  (Action) after Action “**Clear system alarm**”.

Press  (Home) to return to the main screen and log in again as a Basic user (see Section 6.9).

The red tab  (TabM) will now be grey again  (TabM). The system will now continue with an incorrect configuration, but there will no longer be an error indication on the screen (unless another error is active on the system). However, if another System Configuration error is found, the Manager IQ Easy will again give an error message.

6.22 Setting up an FTP connection (Expert user)

Using an FTP connection, it is possible to copy log files stored on the Manager IQ Easy to a local PC or laptop. The Manager IQ Easy must be included in a network for this and be assigned an IP address by the DHCP server of the network. First connect the Manager IQ Easy to your network before you switch on the Manager IQ Easy.

6.22.1 Standard FTP login username and password.

Default FTP login username and password:

For general use, a 'default' username and password are available.

User name: Simco
Password: 1234

6.22.2 Users FTP login username and password.

For better security, however, it is advisable to use your own username and password. To do so, the following settings must be entered in the HMI: "**Remote FTP username**" and "**Remote FTP password**". The setting of parameters and settings is described in Section 6.12. Note that you must be logged in as an Expert user to be able to change these settings.

Furthermore, it is useful to write down the parameter "**Ethernet IP Address**", since it is required for setting up a connection to the FTP server (see Section 6.17.11).

In the following examples, the IQ Easy system will have the IP address 192.168.51.163. This address is entered in the examples.

6.22.3 Setting up an FTP connection with Edge.

Microsoft Edge does not support access to FTP servers. Use a different FTP client.

6.22.3 Setting up an FTP connection with IExplore.

Open IExplore on the PC or laptop



Enter the text "**ftp://**" in the URL bar, supplemented with the FTP address as it is also shown in the HMI under the parameter "**Ethernet IP Address**" (e.g. "<ftp://192.168.51.163>"). Press on the "**Enter**" key.

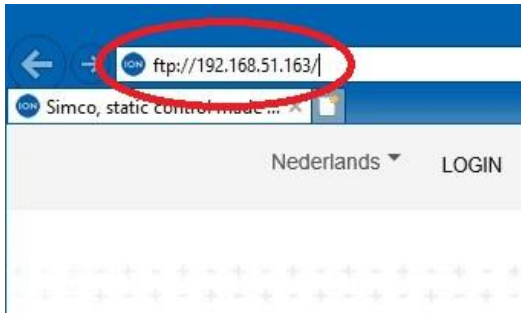

In the screen that opens, enter the username and password.

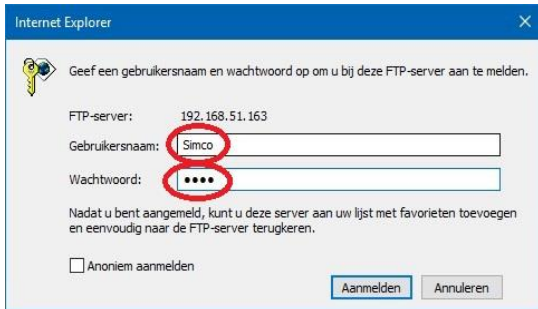

The base directory for the user will be opened.



Select the folder "LogFiles" to go to the folder with all Logfiles.

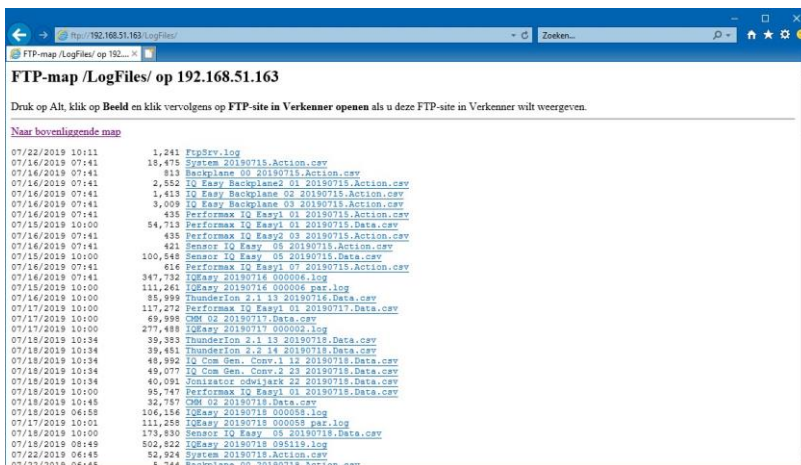

Then copy the desired files to your PC or laptop.

The copied CSV files can be viewed and edited with Excel.

6.22.5 Setting up an FTP connection with Windows Explorer.

Start up Windows Explorer.

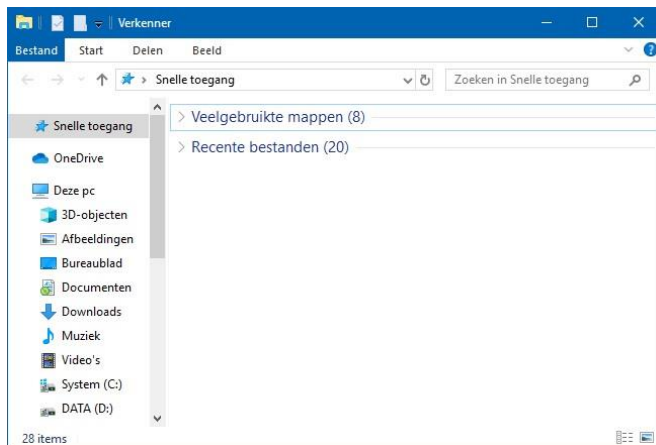

Enter the text “**ftp://**” in the URL bar, supplemented with the FTP address as it is also shown in the HMI under the parameter “**Ethernet IP Address**” (e.g. “<ftp://192.168.51.163>”). Press on the “**Enter**” key.

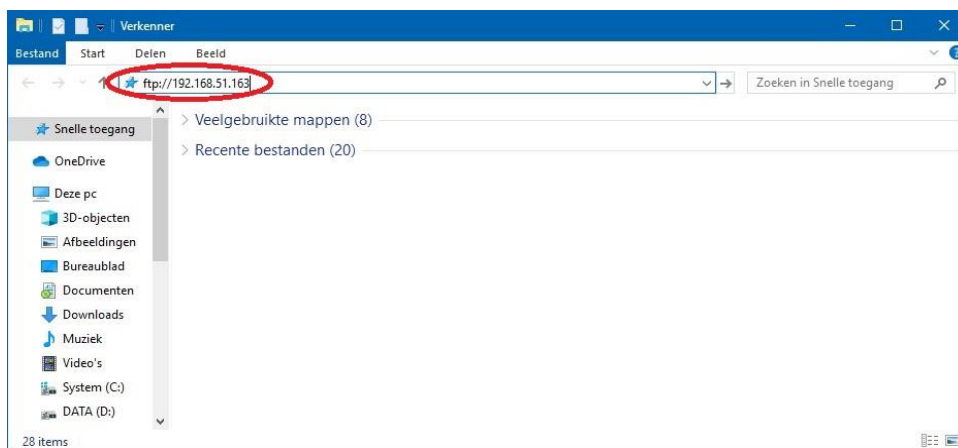

In the screen that opens, enter the username and password and press “**Connect**”.

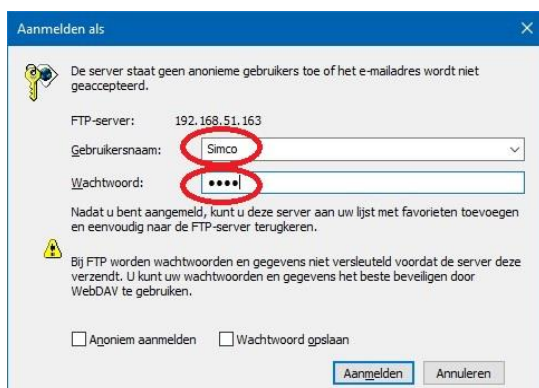

The base directory for the user will be opened.

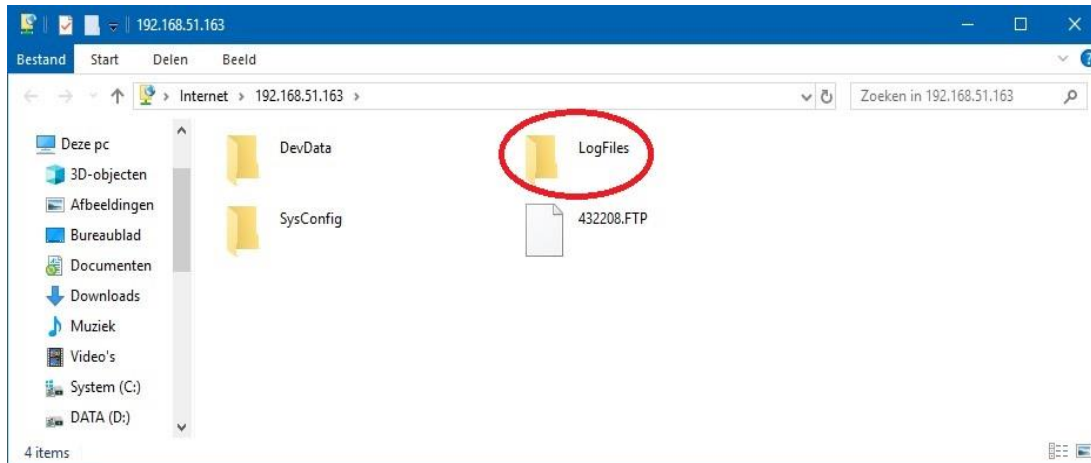

Select the folder “**LogFiles**” via a double click with the left mouse button to go to the folder with all Logfiles.

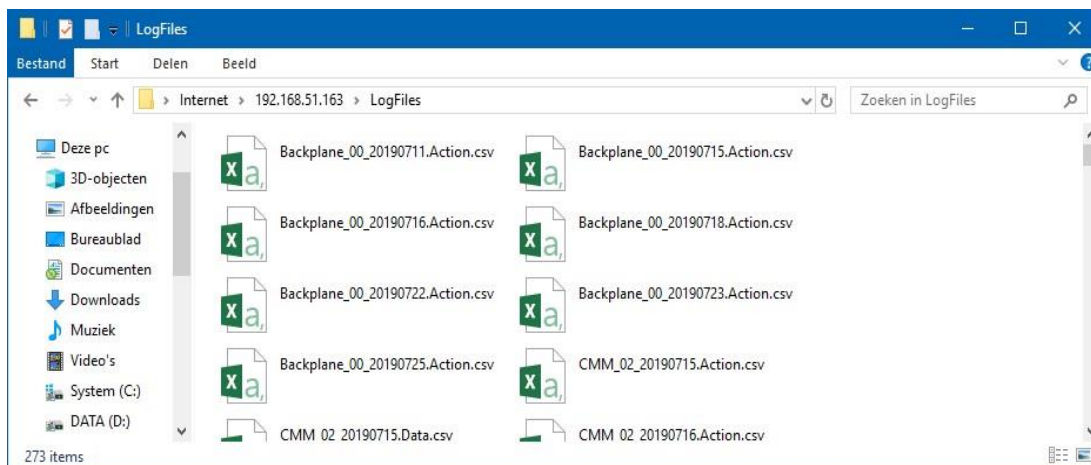

Then copy the desired files to your PC or laptop.

The copied CSV files can be viewed and edited with Excel.

6.22.3 Setting up an FTP connection with FileZilla.



Start FileZilla (FileZilla 3.43.0 was used for the screenshots. If a different version is used, the screens may look different).

Enter the following information:

Host: Ethernet IP Address of the IQ Easy (e.g. 192.168.51.163).
Username: Simco
Password: 1234

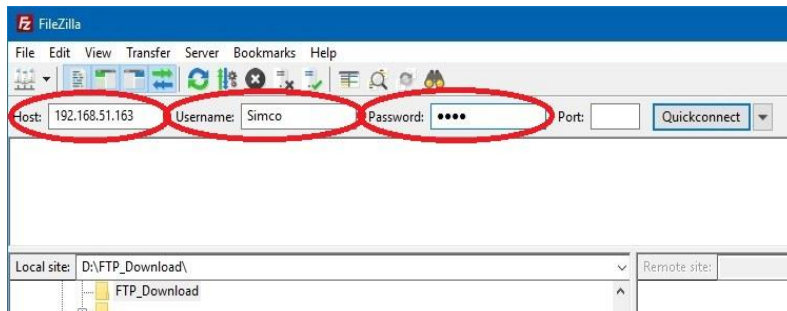

Press **“Quickconnect”**. When the following screen opens, press **“OK”**.

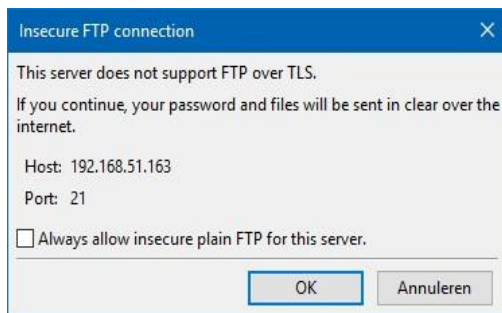

The following screen will open.

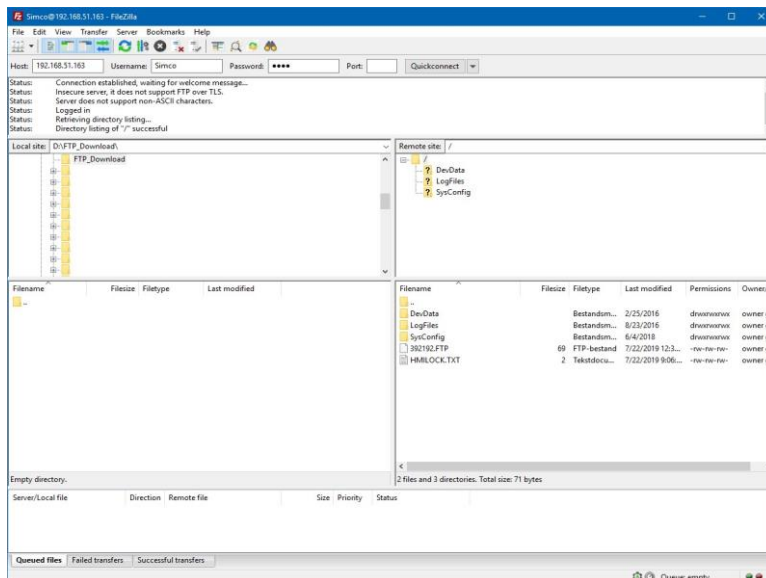

Select the desired **“Local site”**, e.g. **“D:\FTP_Download”**. This can be any folder on your system.

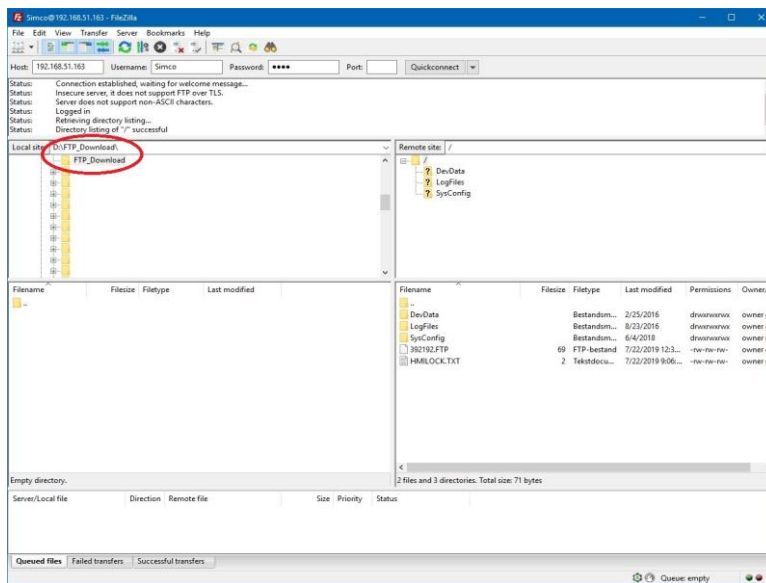

Now double-click on the folder **“LogFiles”** at **“Remote site”**.

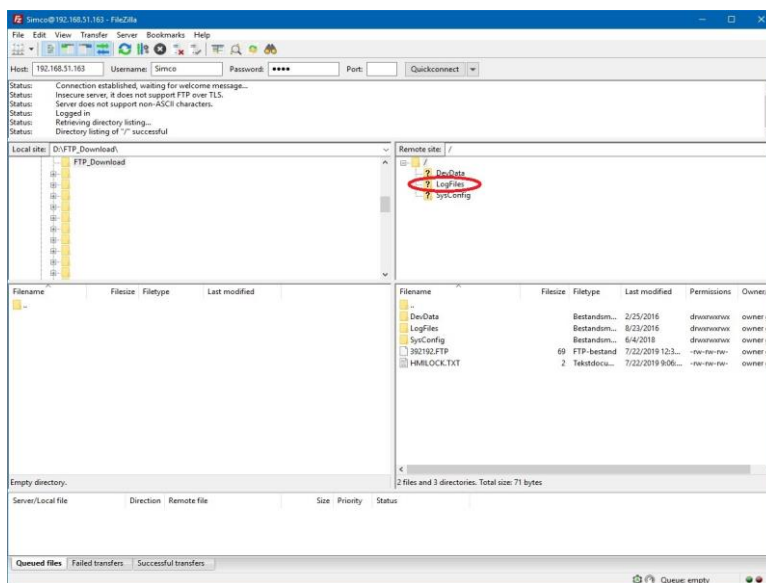

All log files present on the IQ Easy system will then be loaded.

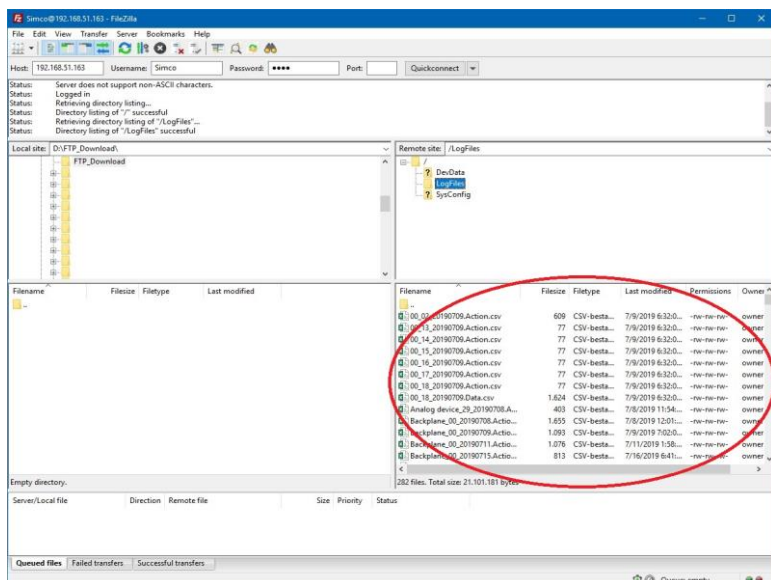

Select the files to copy.

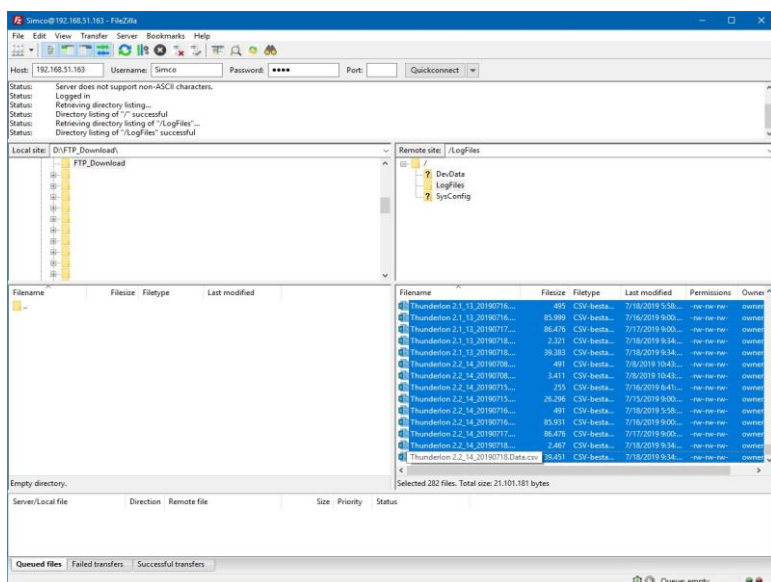

On the list, press the right mouse button and select "Download".

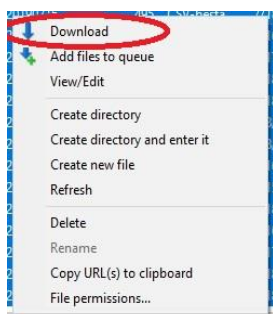

The selected files will now be copied to the PC or laptop.

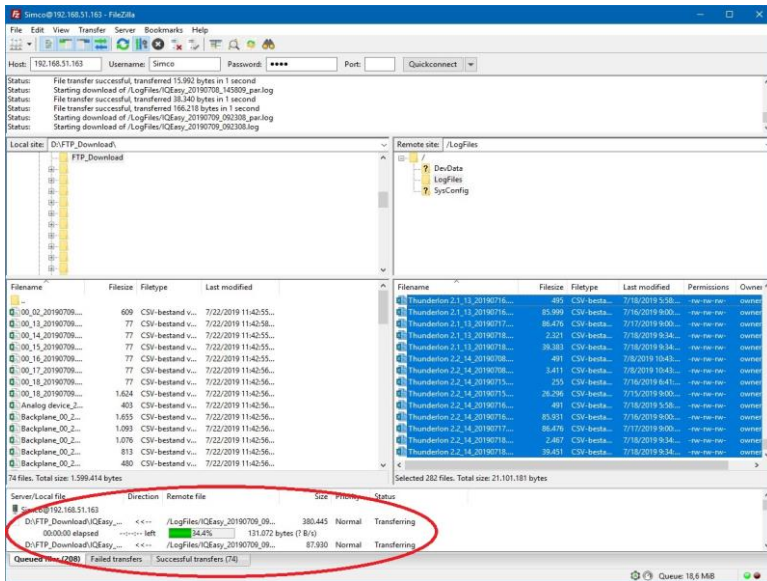

After a while, FileZilla will announce that the copying is done. The files can then be found in the folder specified by the user (see "Local site" e.g. "D:\FTP_Download").

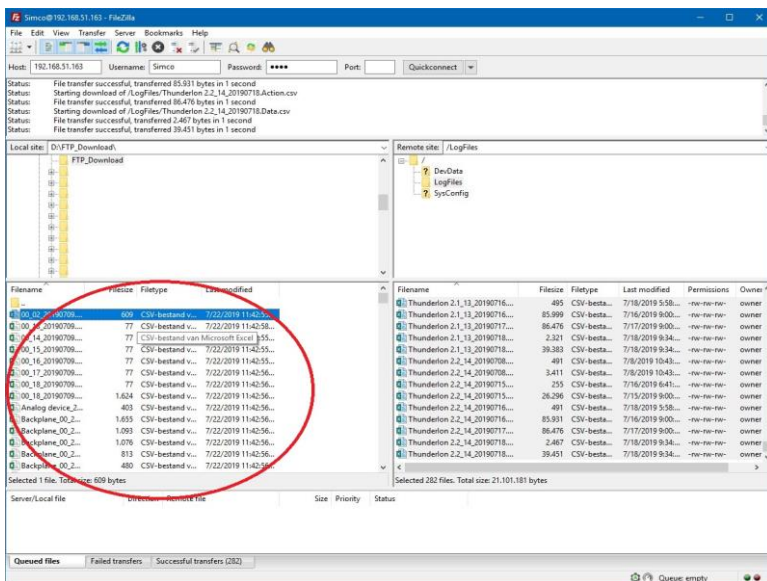

The copied CSV files can be viewed and edited with Excel.

6.23 Copying log files to a USB stick

A USB stick can also be used to copy the log files. Make sure the USB stick contains no other files. Delete any files present on the USB stick.

To copy the files, you only need to insert the USB stick into one of the USB slots of the Manager IQ Easy. After a short wait, the IQ Easy Manager will indicate that the copying has begun via



(Busy). A counter will also be active in the hourglass, which indicates the number of files currently being copied. Depending on the quantity and size of the files, this copying can take some time. When all files have been copied, the Manager IQ Easy will display the following screen:



Remove the USB stick from the USB slot.

Press “**OK**” to close this screen.

Copy the files in the folder “**\LogFiles**” on the USB stick to your PC or laptop.

The copied CSV files can be viewed and edited with Excel.

If the USB stick remains in the Manager IQ Easy, a copying action will be started automatically every day at midnight and all log files present on the system will be copied to the USB stick. After 14 days, log files are automatically deleted from the memory of the Manager IQ Easy, but the log files copied to the USB stick will not be deleted. This means that log files can also be saved automatically for a period longer than 14 days. Please note that the USB stick must have enough free space to store all log files.



Note:

- Copying many or large files can take a lot of time. If the USB stick is removed from the Manager IQ Easy, while it is not finished copying files, files on the USB stick may get corrupted. This may also render the USB unreadable.

6.24 Copying log files including Simco Debug files to a USB stick (Service)



In some cases, you may be asked by a Simco employee to copy so-called “Debug files” to the USB stick. Simco can use these files for analysing problems on your system. By default, these extra files are not copied to the USB stick. To copy these extra files to the USB stick, a special procedure is required.

If necessary, go to the main screen  (Home).

Press ,  or  (User Level).

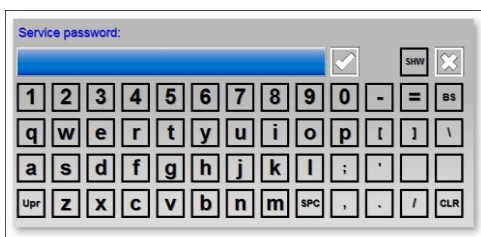
Select “**Service**”. A keyboard will now appear.



Enter the code “**2257**”. The special access code can be made visible while typing by pressing  (Show). Press  (Hide) to hide the special access code again.

Now follow the procedure described in Section 6.23 to copy all log files including the special Debug files to the USB stick.

To send the files to Simco, package the folder “**\LogFiles**” (including all subfolders) on the USB stick in a so-called ZIP file. This will put all files/folders in a single file and compress them. Then send this ZIP file to Simco for analysis.

6.25 Backing up system parameters to USB (Expert user)

The IQ Easy system has the possibility to back up the complete system configuration and all settings and parameters of the system including all connected Devices on a USB stick and thus to make them safe for a possible recovery.

In preparation, a USB stick must be emptied and the folder “**Update**” must be created in the root folder. This prevents all existing log files from being copied to the USB stick first.

If necessary, go to the main screen  (Home).

Place the prepared USB stick in one of the USB slots.

The system will now display the following message “**USB IS UPDATE USB**”.





Press “**OK**”.

If necessary, log in as  (User level, Expert), see Section 6.9.

Press  (Info).

If necessary, press  (Maintenance) to go to Maintenance screen.

Browse using the  and  buttons to the page with the Action “**Save HMI settings**” (You can also use the large non-visible areas to browse).

Press  (Action) after Action “**Save HMI settings**”. After a short while the following screen will appear “**Config files copied.**”.



Press “OK”.

Remove the USB stick from the USB slot and keep it in a safe place.



Press  (Home) to return to the main screen and log in again as a Basic user (see Section 6.9).



Note:

- If within the IQ Easy system software from the HMI, Backplane, Extension IQ Easy units or Devices have been updated, it is possible that the backup made no longer matches the saved system information. Then make a new backup of the system settings.

6.26 Restoring system configuration from a backup (Expert user)

It may happen that an IQ Easy system becomes completely disrupted in one way or another due to settings and adjustments. If a back-up of all system settings was made at an earlier moment when everything did still work, these settings can be retrieved, and with that the system can be made operational again.



Note:

- Before a system backup can be restored, it must first have been made. See Section 6.25.

To restore a backup, perform the following operations.



If necessary, go to the main screen (Home).

Place the USB stick with the system backup in one of the USB slots.

The system will now display the following message **“USB IS UPDATE USB”**.



Press **“OK”**.



If necessary, log in as (User level, Expert), see Section 6.9.



Press (Info).



If necessary, press (Maintenance) to go to Maintenance screen.



Browse using the and buttons to the page with the Action **“Restore HMI settings”** (You can also use the large non-visible areas to browse).



Press (Action) after Action **“Restore HMI settings”**. After a while, the following screen will appear **“Config files restored.”**.



Press **“OK”**.

Then, all the parameters and settings of the system will also be reset. This can take some time, depending on the size of the system.

Remove the USB stick from the USB slot and keep it in a safe place.





Press  (Home) to return to the main screen and log in again as a Basic user (see Section 6.9).

6.27 Searching for newly added Extension IQ Easy units

6.27.1 Searching manually for Extension IQ Easy units.



To add a newly connected Extension IQ Easy to the system immediately, or if automatic search is disabled (see Section 6.27.2), the manual search for Extension IQ Easy units can be performed.

If necessary, go to the main screen  (Home).

If necessary, log in as  (User level, Expert), see Section 6.9.

Press  (Info).

Press  (Maintenance) to go to the Maintenance screen.

Browse using the  and  buttons to the page with the Action “**Scan Ext. Boxes**” (You can also use the large non-visible areas to browse).

Press  (Action) after Action “**Scan Ext. Boxes**”.

The IQ Easy system will now search for undetected Extension IQ Easy units. As soon as an

Extension IQ Easy is found, the corresponding tab will be added in the main screen, the 

(Info) button will change into a  (Busy) button and the Extension IQ Easy will be read in with all connected Devices.

Press  (Home) to return to the main screen and log in again as a Basic user (see Section 6.9).

6.27.2 Searching manually for Extension IQ Easy units.

The IQ Easy system will normally automatically look for newly connected Extension IQ Easy units and add them to the system. The time interval for searching for newly connected Extension IQ Easy units determines parameter “**Rescan Ext.Box timer**”.



Depending on the system load, a different value can be set here. If the value is set to “**0 seconds**”, newly connected Extension IQ Easy units will not be automatically searched for. With system adjustments this can be done manually (see Section 6.27.1).

The parameter can be adjusted as follows.

If necessary, go to the main screen  (Home).

If necessary, log in as  (User level, Expert), see Section 6.9.

Press  (Info).

Browse using the  and  buttons to the page with the parameter “**Rescan Ext.Box timer**” (You can also use the large non-visible areas to browse).

Click  (EditMode) to change the parameter.

Press  (Edit) after the “**Rescan Ext.Box timer**” parameter. A keyboard will now be opened.

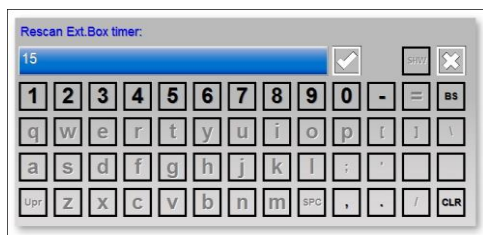

Enter the desired scan time (value in seconds). Good values are, for example, 15, 30 or 60. If the value is set to 0, the IQ Easy system will no longer automatically search for newly connected Extension IQ Easy units.

Press  (Home) to return to the main screen and log in again as a Basic user (see Section 6.9).

6.28 Disconnecting a Device (Expert user)

6.28.1 Device disconnected notification.

If communication with a Device is lost before the time set via the Backplane “**Device timeout**”, the Device will be reported as ‘Disconnected’. This can possibly be made visible via a pop-up screen to attract the attention of the user (see parameter “**Popup on disconnected device**”). This Alarm message will also be found in the ActionLog of the Device and the HMI (“**DEVICE COMMUNICATION LOST**”).



Press “**OK**” to close the pop-up message.

The Device button will now have a red  background and the following status icon .



6.28.2 Restoring a disconnected Device.

The IQ Easy Manager will continue to attempt to restore communication with the Device. If communication with the Device can be restored, the Manager IQ Easy will restore the situation of the automatic Device. While the Device is being restored, the background colour of the

Device will turn yellow .



After a short time, the Device will function as before.

6.28.3 Removing the Disconnected Device from the IQ Easy system.



However, if a Device is disconnected from the system and will not be replaced, the Device can be removed from the system so that the error status of the Device is removed.

If necessary, go to the main screen  (Home).

If necessary, log in as  (User level, Expert), see Section 6.9.

Press , ,  or  (Device).

If necessary, press  (Maintenance) to go to Maintenance screen.

Browse using the  and  buttons to the page with the Action “**Disconnect Device**” (You can also use the large non-visible areas to browse).

The following screen will be opened:



Press “**YES**” if the Device will be replaced by another Device and the parameters of the current Device must be transferred. The parameters of the current Device will now be saved on the system (see Section 6.29.2).

Press “**NO**” if it is not desired to keep the parameters and settings of the current Device.

The screen will now close.

Press  (Home) to return to the main screen and log in again as a Basic user (see Section 6.9).

6.29 Replacing a defective Device (Expert user)

In the unlikely event that a Device has failed and needs to be replaced by another Device, the IQ Easy System has the option of taking over the parameters and settings of the defective Device when connecting the replacement Device. The user does not have to re-enter all parameters and settings for this.

However, to make this possible, the parameters and settings of the defective Device must still be present on the system or must be stored on the system. This is described in Section 6.28.3.

There are several options for transferring the information from the original Device to the replacement Device. These options will now be described.

6.29.1 The Device information is still available in the memory of the Manager IQ Easy.

If a defective Device is no longer able to communicate with the Manager IQ Easy or if a Device is disconnected from the IQ Easy system, the Manager IQ Easy will detect this via a “**Device disconnected**” notification to the user. At that time, the status colour of the Device is red



and the Device icon replaced with a



The user still has access to the Device’s settings at the time before the Device was disconnected.

The Device must now be reported as ‘Disconnected’ before the new Device can be connected. Follow the procedure described in Section 6.28.3 to save the settings on the system. For the question “**Device will be removed. Save params?**”, choose “**YES**”.

Now follow the procedure in Section 6.29.2 to connect the new Device and transfer the settings from the defective Device to the new Device.

6.29.2 The Device information is stored on the system.

If a defective Device is no longer able to communicate with the Manager IQ Easy or if a Device is disconnected from the IQ Easy system, the Manager IQ Easy will detect this via a “**Device disconnected**” notification to the user.

The user has, as described in Section 6.28.3, the possibility to actually remove the Device from the system.

If, when deleting the settings of the defective Device, the user has chosen to save the settings to the Manager IQ Easy, these saved settings can be transferred to a newly connected Device using the following procedure.

Connect a new Device not previously connected to an IQ Easy System to the corresponding port of the Manager IQ Easy or the Extension IQ Easy.

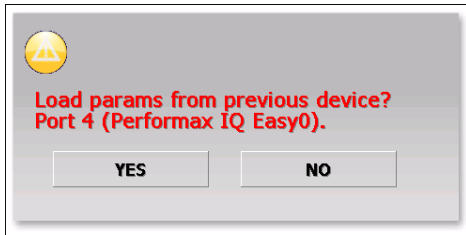

The following screen will then appear (the port number and device name may differ).



Press “**YES**” to take over the parameters of the previous failed Device.

The screen will close and the settings will be copied to the Device. During this process, the

Device status will be displayed as  /  (Busy). When copying the settings is complete,

the status will change to  /  (Running) or  /  (Standby) mode.

6.29.3 There is no longer any information from the defective Device available for the Manager IQ Easy.

In the worst case scenario, the information of the defective or removed Device is no longer stored in the memory of the Manager IQ Easy and also not on the system (see Section 6.28.3). In this case, all settings of the new Device will have to be adjusted manually.

6.30 Calibrating a bar (Expert user)



If it is necessary to calibrate a bar, follow the following procedure. To be able to calibrate a bar, the user must be logged in as an Expert (see Section 6.8).

If necessary, go to the main screen  (Home).

If necessary, log in as  (User level, Expert), see Section 6.9.

Press  or  (Device).

If necessary, press  (Maintenance) to go to the Maintenance screen.

Browse using the  and  buttons to the page with the Action “**Calibrate bar**” (You can also use the large non-visible areas to browse).

Press  (Action) after Action “**Calibrate bar**”.

Within a few seconds, after the Action button the message “**Calibration started...**” will be displayed, and shortly thereafter this will be followed by the message “**Calibration in progress (10%)...**”. The counter will slowly increase until the bar calibration is complete. The text will disappear when the calibration is complete. In the “**Last calibration date**” parameter the current date and time will be saved.

Note:

- Sometimes the counter stays at 70%. In this case, disconnect the Device, wait about 10 seconds, and reconnect the Device. Check if necessary whether the current date and time have been saved in the parameter “**Last calibration date**”. In that case, the bar is correctly calibrated.

Press  (Home) to return to the main screen and log in again as a Basic user (see Section 6.9).



6.31 Fieldbus settings (Expert user)

Note:

- To support the fieldbus capabilities of the Manager IQ Easy system, not only must the Anybus module intended for your network be mounted (see 5.4.5) but a special version of the Backplane software must also be installed on your system.

If the Manager IQ Easy is equipped with a Fieldbus interface, you have the option of operating the Manager IQ Easy via, for example, a PLC. This includes options to put Devices via the PLC into Standby and/or Run mode, but also to read back values measured by the Device (including Web voltage) or to make specific settings (including Setpoint voltage).

Note:



- If the IQ Easy Manager is active in fieldbus mode, the  (Stand-by) and  (Run) buttons are disabled. The PLC will then be the master of the system via the fieldbus and will determine which Devices will be set to Standby and Run.



6.31.1 Setting up the use of a DHCP server.

It is preferable to have the Fieldbus module assign a network address via a DHCP server. To do this, set the parameter “**Use DHCP**” to “**Yes**”. This will reduce the chance of double addressing or incorrect addressing. However, if it is desired that the Fieldbus module be assigned a specific network address and you want to enter it yourself, set the parameter “**Use DHCP**” to “**No.**”.

If necessary, go to the main screen  (Home).

If necessary, log in as  (User level, Expert), see Section 6.9.

Press  (TabM) and press  (Info) within 1 second. The Information screen of the Backplane will now be opened.

Browse using the  and  buttons to the page with the parameter “**Use DHCP**” (You can also use the large non-visible areas to browse).

Click  (EditMode) to change the parameter.

Press  (Edit) after the “**Use DHCP**” parameter. The following screen will be opened.

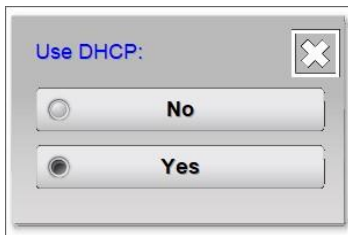

Select the desired setting. The screen will now close.



Press  (Home) to return to the main screen and log in again as a Basic user (see Section 6.9).

If the parameter “**Use DHCP**” is set to “**No**”, adjust the following parameters if necessary: “**DNS1**”, “**DNS2**”, “**IP Address**”, “**IP Subnet mask**”, “**IP Gateway**”, “**Domain name**” and/or “**Host name**”.



Note:

- Incorrectly setting 1 or more of these parameters may lead to communication problems on your network or prevent the Fieldbus module in the network from being detected, or there may be communication problems.

6.31.2 Setting the network parameters with IPconfig tool (ProfiNet and EtherNet/IP only).

The IPconfig tool can best be used to set the basic settings of the Fieldbus module. The IPconfig tool can be downloaded via the link <https://www.anybus.com/support/file-doc-downloads/anybus-support-tools?orderCode=tools>.

Install the IPconfig tool on your laptop or PC. Start the HMS tool **IPconfig**. The following screen will appear: If the (new) Fieldbus dongle is not visible in the list, press “**Scan**” to search for existing Fieldbus modules in the network.

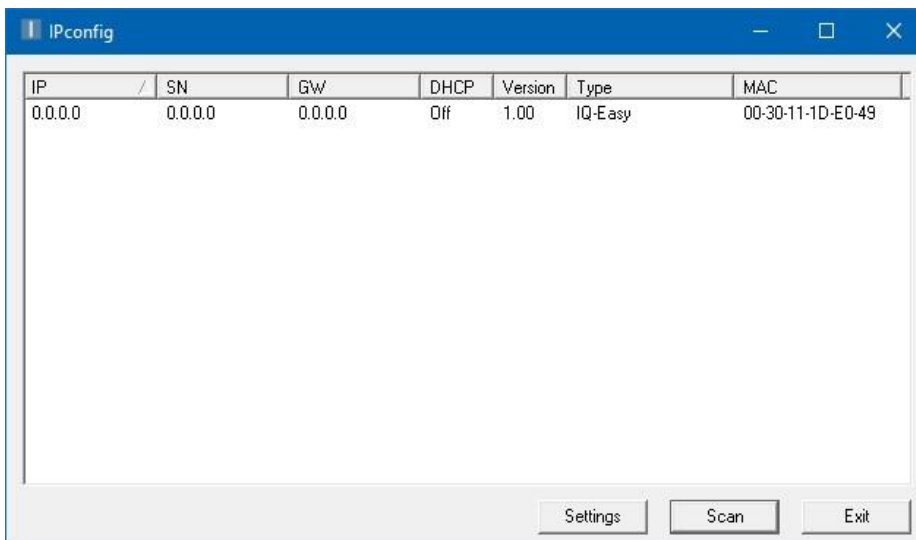

Double-click on the newly found Fieldbus dongle (IP address is 0.0.0.0).

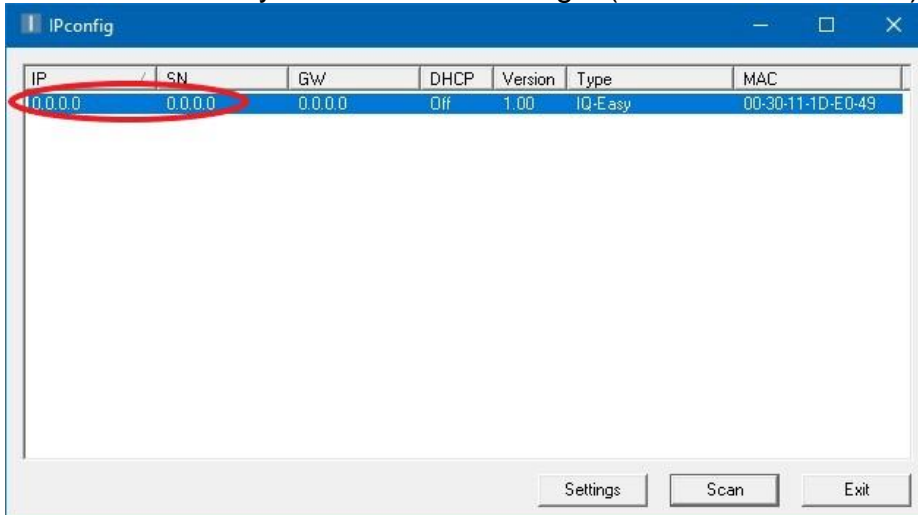

The following screen will be opened.

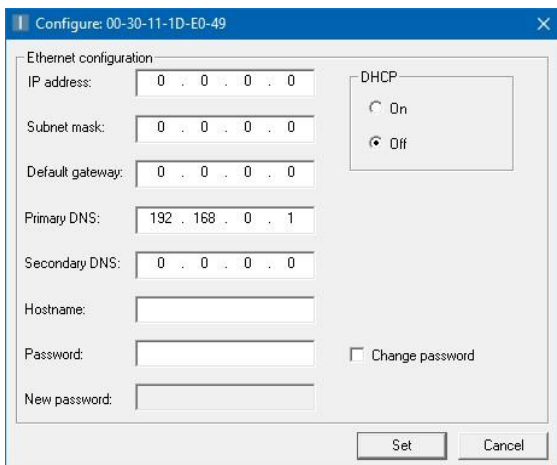

If it is desired to have the Fieldbus module assign an address via a DHCP server, follow the instructions in Section 6.31.2.1. Follow the instructions in Section 6.31.2.2 to enter the network settings manually.

6.31.2.1 Setting the Fieldbus network parameters using a DHCP server.

At “**DHCP**”, select the option “**On**” to assign the IP address for the Fieldbus dongle via a DHCP server.

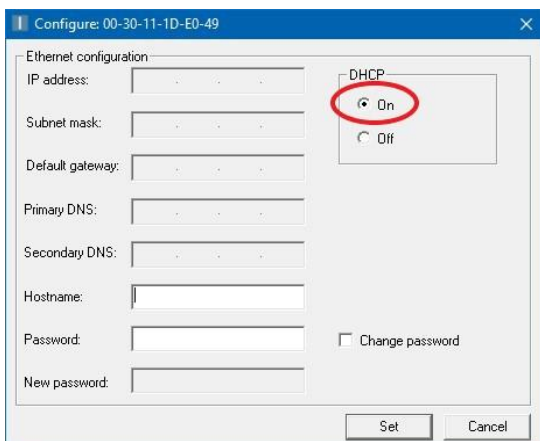

Then, at **“Hostname”**, enter a recognisable name such as **“IQ-Easy”**.

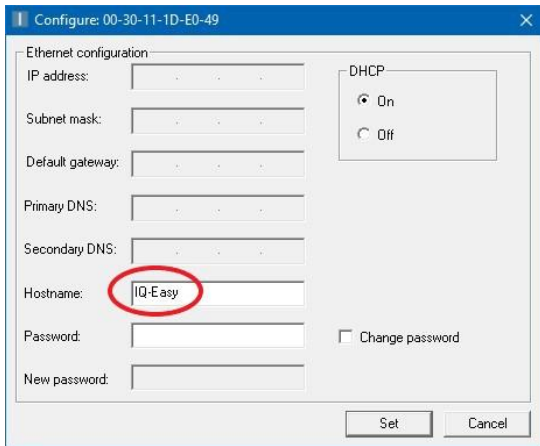

Click on **“Set”** to apply the settings.

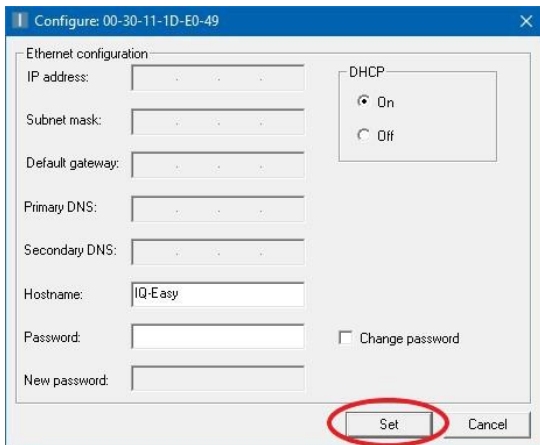

To make the settings also visible on the Manager IQ Easy, the Manager IQ Easy must be restarted.

6.31.2.2 Setting the Fieldbus network parameters without using a DHCP server.

At **“DHCP”**, select the option **“Off”** to enter the IP address for the Fieldbus dongle yourself.

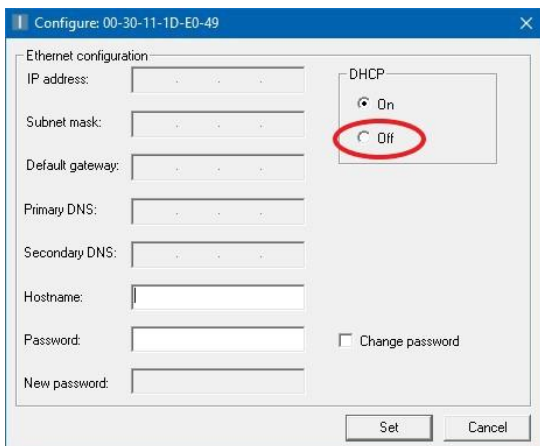

At “**IP address**”, “**Subnet mask**”, “**Default gateway**” and “**Primary DNS**”, enter the correct network information.

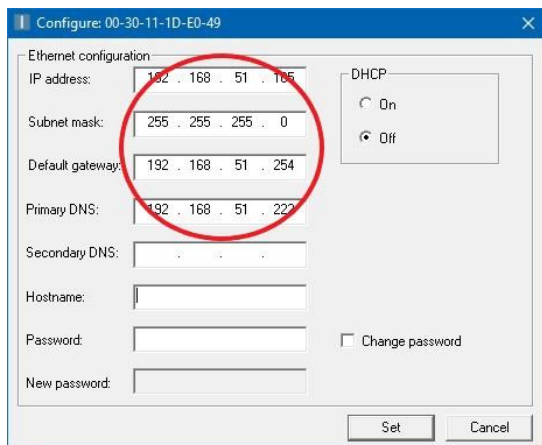

Then, at “**Hostname**”, enter a recognisable name such as “**IQ-Easy**”.

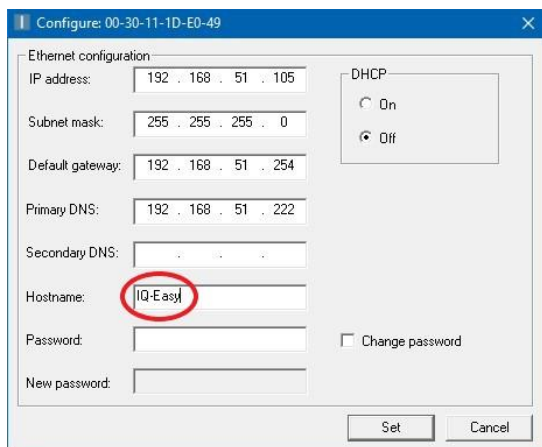

Click on “**Set**” to apply the settings.

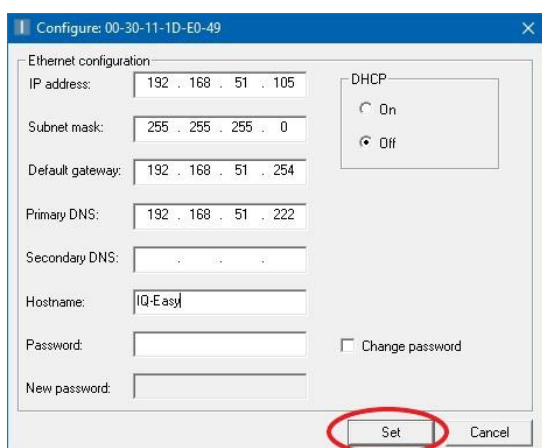

To make the settings also visible on the Manager IQ Easy, the Manager IQ Easy must be restarted.

6.31.3 Setting the parameters “Domain name”, “Host name” (ProfiNet and EtherNet/IP only).

Open Microsoft “Edge”, Microsoft “Internet Explorer”, Google “Chrome” or another browser.

Enter the IP address of the Manager IQ Easy in the search bar (e.g. “http://192.168.51.94”).

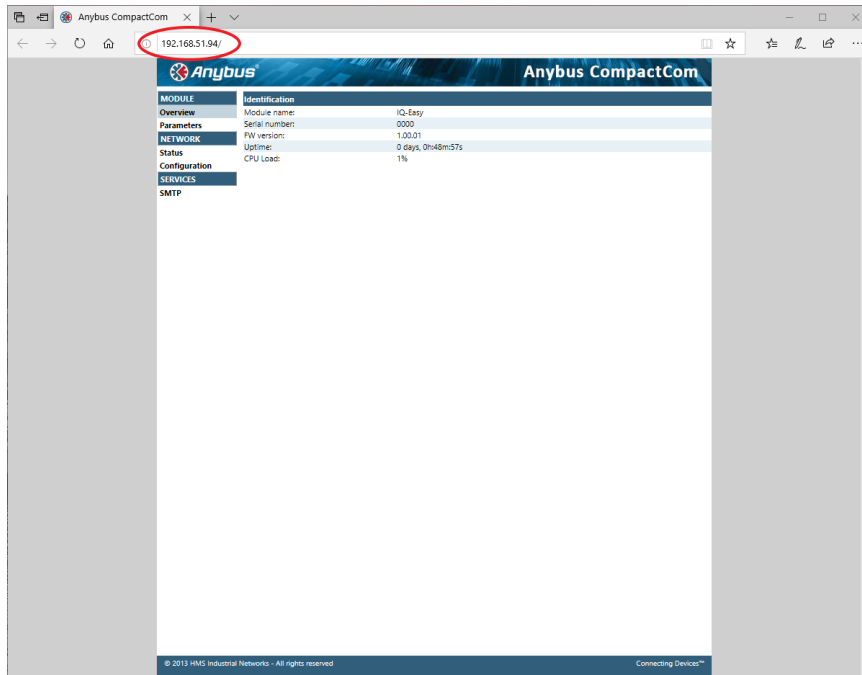

Then click on “Configuration”. The following screen will open.

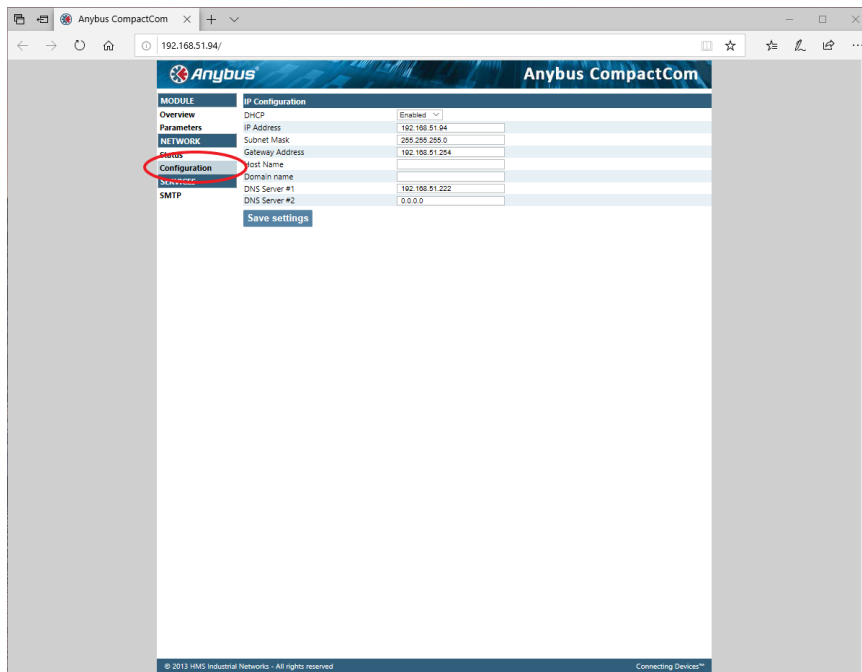

At “**Host name**”, enter the desired Host name, e.g. “**IQ-Easy**”.
At “**Domain name**”, enter the network domain name (in this example “**simco-ion.local.nl**”).

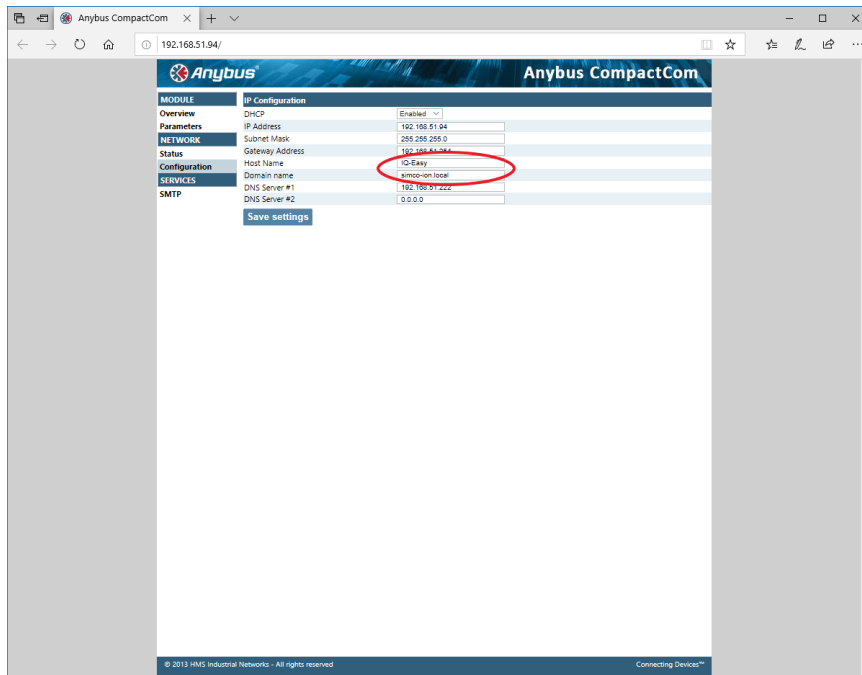

Now press “**Save settings**”.

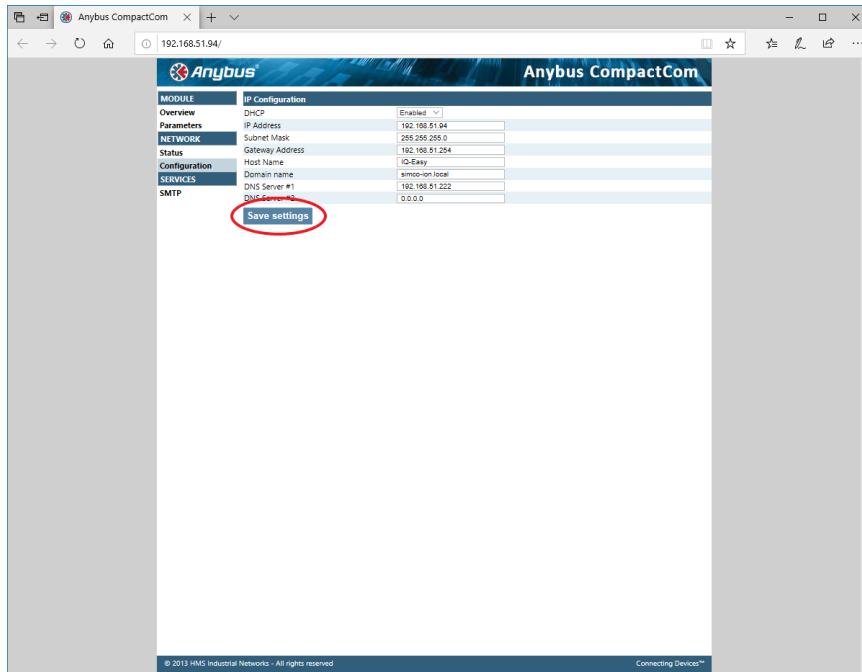

6.31.4 Setting the network Device name (ProfiNet only)

To make the Manager IQ Easy (Fieldbus) module visible in the ProfiNet network, the Manager IQ Easy (Fieldbus) module must be given a name. This cannot be set via the Manager IQ Easy and the ProfiNet tool PROTENA from Siemens must be used.

The tool can be downloaded via the link

<https://support.industry.siemens.com/cs/document/67460624/proneta-2-7-0-3-commissioning-and-diagnostics-tool-for-profinet?dti=0&lc=en-WW>.

Start the Siemens tool **PRONETA**.

Click on **“Network analysis”**.

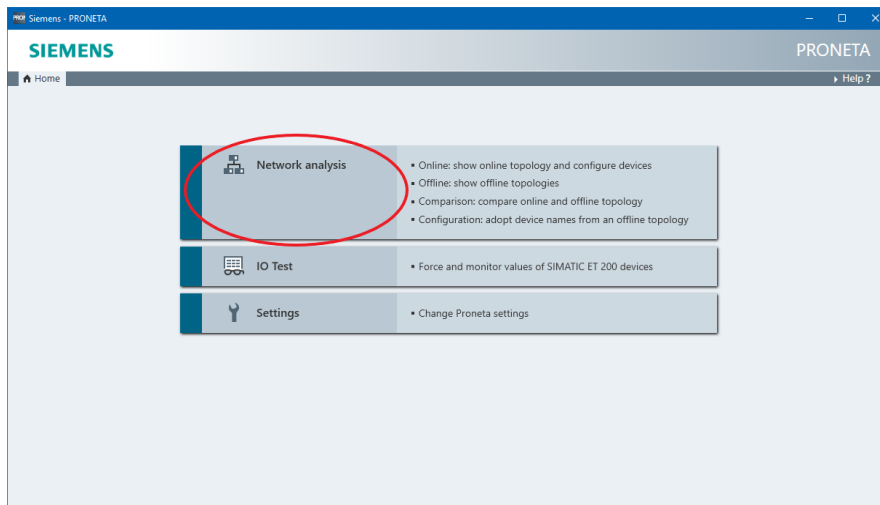

Click with the right mouse button on the Manager IQ Easy module.

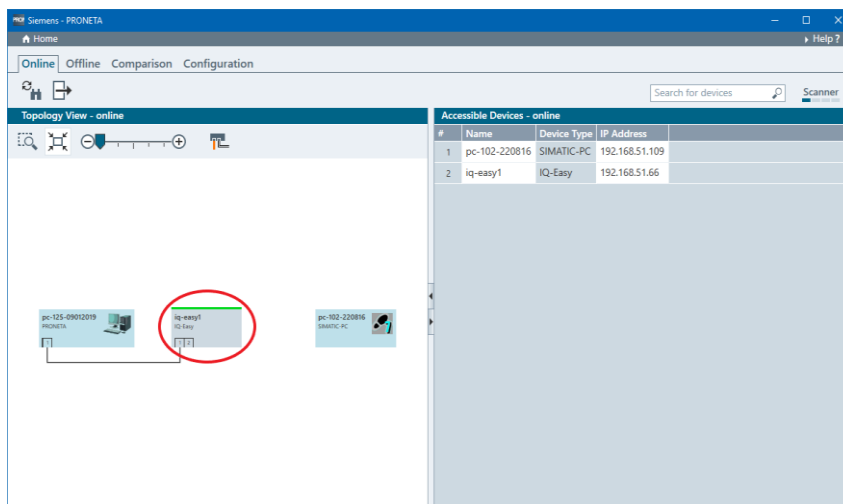

The following pop-up screen will open.

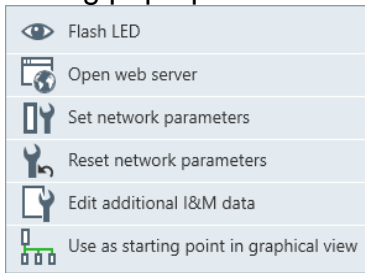

Click on **“Set network parameters”**.

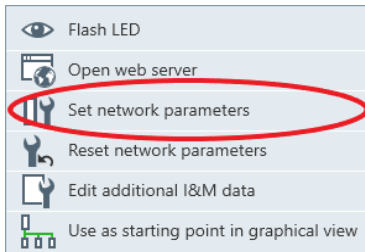

The following screen will open.

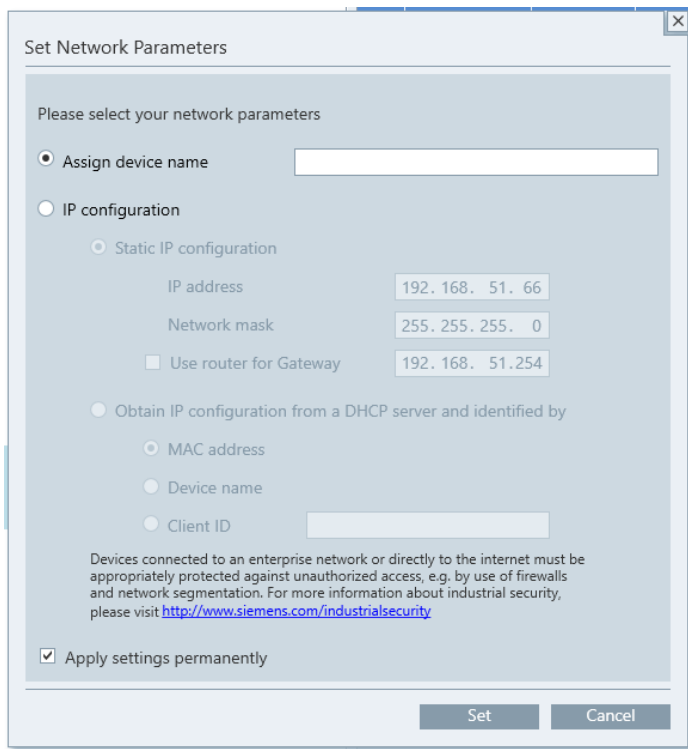

Set Network Parameters

Please select your network parameters

- Assign device name
- IP configuration
 - Static IP configuration
 - IP address
 - Network mask
 - Use router for Gateway
 - Obtain IP configuration from a DHCP server and identified by
 - MAC address
 - Device name
 - Client ID

Devices connected to an enterprise network or directly to the internet must be appropriately protected against unauthorized access, e.g. by use of firewalls and network segmentation. For more information about industrial security, please visit <http://www.siemens.com/industrialsecurity>

Apply settings permanently

At “**Assign device name**”, enter the name of the Manager IQ Easy module, e.g. “**IQ-Easy**”.

Set Network Parameters

Please select your network parameters

Assign device name

IP configuration

Static IP configuration

IP address

Network mask

Use router for Gateway

Obtain IP configuration from a DHCP server and identified by

MAC address

Device name

Client ID

Devices connected to an enterprise network or directly to the internet must be appropriately protected against unauthorized access, e.g. by use of firewalls and network segmentation. For more information about industrial security, please visit <http://www.siemens.com/industrialsecurity>

Apply settings permanently

Set Cancel

Press “**Set**”.

Set Network Parameters

Please select your network parameters

Assign device name

IP configuration

Static IP configuration

IP address

Network mask

Use router for Gateway

Obtain IP configuration from a DHCP server and identified by

MAC address

Device name

Client ID

Devices connected to an enterprise network or directly to the internet must be appropriately protected against unauthorized access, e.g. by use of firewalls and network segmentation. For more information about industrial security, please visit <http://www.siemens.com/industrialsecurity>

Apply settings permanently

Set Cancel

The Manager IQ Easy can now be found in the ProfiNet network with the name “**IQ-Easy**”.

6.31.5 Setting the “Fieldbus Device ports” mapping parameter(s)

The IQ Easy System has the option to connect Devices to different ports. Due to the flexibility of the system, Devices can therefore be connected to any port. However, within the defined Fieldbus structures, this is not that flexible. Therefore, the Devices connected to the IQ Easy system must be mapped onto the Fieldbus structure. The following parameters are used for this:

- **“Fieldbus Sensor ports”**
- **“Fieldbus PerflQ ports”**
- **“Fieldbus PerflQ-Ex ports”**
- **“Fieldbus TH2 ports”**
- **“Fieldbus CMM ports”**
- **“Fieldbus CM-Tiny ports”**
- **“Fieldbus GenConv ports”**

An example will make it clear how Device mapping works. As an example, we have a system with the following Devices:

Port 1: Sensor IQ Easy	Device name: “Sensor1”
Port 2: Performax IQ Easy	Device name: “Laadstaaf1”
Port 5: Sensor IQ Easy	Device name: “Sensor2”
Port 6: Performax IQ Easy	Device name: “Laadstaaf2”

In the Fieldbus structure we want to map the Devices as follows:

“Fieldbus Sensor Ports“ Mapping #1:	Sensor IQ Easy “Sensor2“
“Fieldbus Sensor Ports“ Mapping #2:	Sensor IQ Easy “Sensor1“
“Fieldbus PerflQ Ports“ Mapping #1:	Performax IQ Easy “Laadstaaf1“
“Fieldbus PerflQ Ports“ Mapping #2:	Performax IQ Easy “Laadstaaf2“

The mapping parameters must be entered as follows:

- **“Fieldbus Sensor ports”** 5, 1
- **“Fieldbus PerflQ ports”** 2, 6

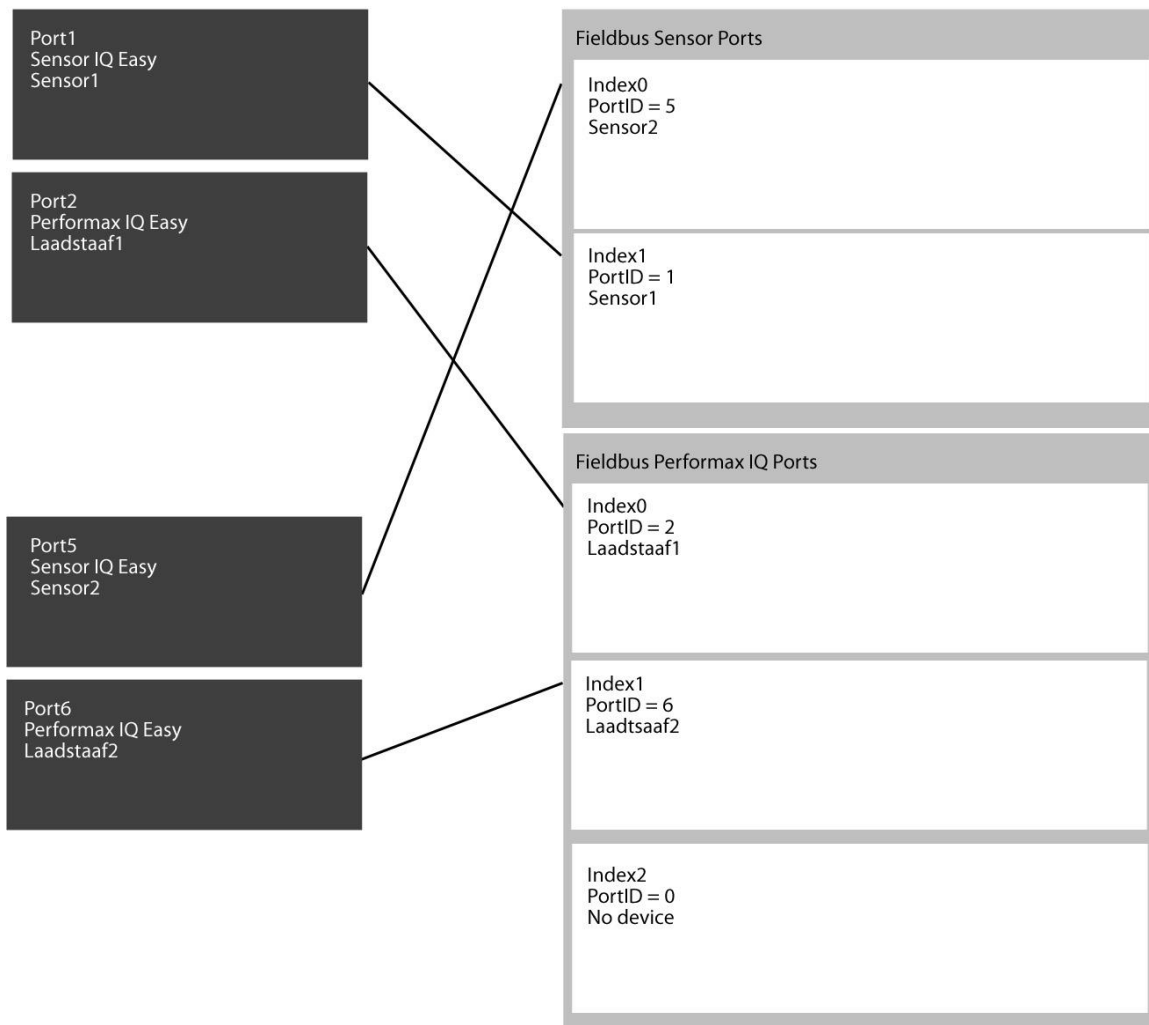

The mapping then looks schematically as follows:





Adjusting the “**Fieldbus <Device type> ports**” parameter goes as follows.

If necessary, go to the main screen  (Home).

If necessary, log in as  (User level, Expert), see Section 6.9.

Press  (TabM) and press  (Info) within 1 second. The Information screen of the Backplane will now be opened.

Browse using the  and  buttons to the page with the parameter “**Fieldbus <Devicetype> ports**” (You can also use the large non-visible areas to browse).

Click  (EditMode) to change the parameter.



Press  (Edit) after the “**Fieldbus <Device type> ports**” parameter. The following screen will be opened.

Fieldbus Sensor ports:

#1 None

#2 None

#3 None

Select the desired mapping position (Select an existing mapping to change or delete it if necessary).

Fieldbus Sensor ports:

#1 None

#2 None

#3 None

The following screen will be opened.

Device Port:

None

Performax IQ Easy1

Port 2 (Not connected)

Performax IQ Easy2

Port 4 (Not connected)

Sensor IQ Easy

Port 6 (Not connected)





If necessary, browse using the  and  buttons to the page with the Device which is to be mapped.

Now press the button of the Device to be mapped (select “**None**” to undo a mapping).

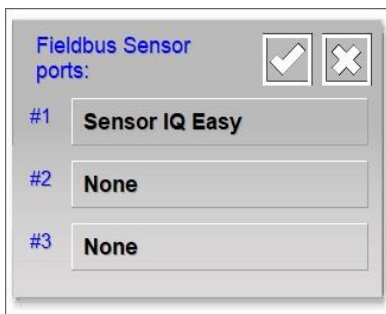

The screen will now close.



The added Device will now be found in the overview. If necessary, add another Device in a free position as described above. When all Devices are mapped, press  (Accept) to complete the mapping of the Devices and save the mapping created.



Note:

- In the above example, only Sensor Devices are mapped. A separate mapping must be created for all types of Devices.



Press  (Home) to return to the main screen and log in again as a Basic user (see Section 6.9).



Note:

- **After adjustments have been made in the “Device port mapping” parameter(s), the Manager IQ Easy will have to be closed and restarted. This for correct operation of the newly defined structures (see 6.16).**

6.31.6 Setting the “Fieldbus smart sensor data msg” parameter

This parameter determines how the various available sensor segments are displayed in the fieldbus messages. If the “**Fieldbus smart sensor data msg**” is set to “**No**”, the segments will be mapped 1 to 1 with the messages. If the parameter is set to “**Yes**”, the first active sensor segment will be in the first message, the second active sensor segment will be in the second message, and so on.



To clarify this, we take the following example. We have a sensor rod with 6 docking positions. A sensor is only placed at positions 1, 3 and 6, positions 2, 4 and 5 are empty. There are 3 sensor data elements defined for the Fieldbus.



Fieldbus sensor data position	“ Fieldbus smart sensor data msg ”	
	No.	Yes
#1	Sensor segment # 1	Sensor segment # 1
#2	No	Sensor segment # 3
#3	Sensor segment # 3	Sensor segment # 6

To set the “**Fieldbus smart sensor data msg**” parameter, perform the following actions:

If necessary, go to the main screen  (Home).

If necessary, log in as  (User level, Expert), see Section 6.9.

Press  (TabM) and press  (Info) within 1 second. The Information screen of the Backplane will now be opened.

Browse using the  and  buttons to the page with the parameter “**Fieldbus smart sensor data msg**” (You can also use the large non-visible areas to browse).

Click  (EditMode) to change the parameter.

Press  (Edit) after the “**Fieldbus smart sensor data msg**” parameter. The following screen will be opened.

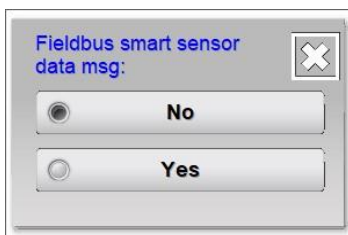

Select the desired setting. The screen will now close.

Press  (Home) to return to the main screen and log in again as a Basic user (see Section 6.9).

6.31.7 Meaning of status LEDs Fieldbus module

Link LED.

LED status	Description	Comments
Off	No connection	No connection, no communication.
Green	Connection	Ethernet connection stable, no communication.
Flashing green	Activity	Ethernet connection stable, communication.

6.31.7.1 Meaning of status LEDs EthetNet/IP Fieldbus module

NS LED (Network Status).

LED Status	Description
Off	No voltage or no IP address set.
Green	Online, one or more communication connections made.
Flashing green	Online, no communication connections made yet.
Red	IP address used twice, fatal error.
Flashing red	Timeout of one or more communication connections.

MS LED (Module Status).

LED Status	Description
Off	No voltage.
Green	Controlled by means of a PLC or other master in "Run" state.
Flashing green	Not configured, PLC or other master in "Idle" mode.
Red	Serious mistake.
Flashing red	Correctable error.

6.31.7.2 Meaning of status LEDs of the Profinet Fieldbus module

NS LED (Network Status).

LED status	Description	Comments
Off	Offline	No voltage. No connection to the IO controller.
Green	Online (Run)	Connection to the IO controller. IO controller in Run state.
Green, 1x flashing	Online (Stop)	Connection to the IO controller. IO controller in Stop state or wrong IO data. IRT synchronisation not ready.
Flashing green	Blink	Used by engineering tools to determine the node in the network.
Red	Fatal event	Major internal error (this is combined with a red module LED).
Red, 1x flashing	Station name error	The station name is not set.
Red, 2x flashing	IP address error	The IP address is not set.
Red, 3x flashing	Configuration error	The expected identification does not match the real identification.

MS LED (Module Status).

LED status	Description	Comments
Off	Uninitialised	No voltage or module is in the SETUP or NW_INIT state.
Green	Working normally	The module is out of the NW_INIT state.
Green, 1x flashing	Diagnostic event(s)	Diagnostic event(s) available.
Red	Exception error	Device is in the EXCEPTION state.
	Fatal event	Major internal error (this is combined with a red network status LED)
Alternately flashing red/green	Firmware update	Do not turn the IQ Easy Manager off. By de-energising the Manager IQ Easy, the Fieldbus module will be irreparably damaged.

6.31.8 Setting up PLC for fieldbus communication

The configuration of the PLC for the fieldbus communication can be found in the manual "*ManagerIQEasy_UM_Profinet_configuration_GB_V2_0.pdf*". Download this document from the Simco-ion homepage or contact your agent for a copy.

7 Functional check

The Manager is operating properly if the (Device) icons are visible and the status of the connected Devices is displayed on the main screen  (Home). Devices connected to one

7.1 Warnings

The Manager generates a warning when a Device or the Manager detects a situation requiring the user's attention. The particular Device will keep functioning and, if necessary, be switched into a safe mode. A warning will be displayed with an orange/yellow indication in the Device icons. The Manager or Extension IQ Easy tab will also turn yellow to indicate that there is a warning in this box.

7.2 Alarms

The Manager generates an alarm if a Device or the Manager detects a situation in which the values set by the user or Simco-Ion are exceeded, which may lead to a dangerous situation. To prevent damage, the relevant Device will be switched off in most cases. An alarm with a red indication will be displayed. The Manager or Extension IQ Easy tab will also turn red, indicating that there is an alarm in this box.

If a Device stops communicating or is disconnected from the system, an alarm is also generated.

If it is set for the system that the active configuration must be checked, deviations in the configuration will also be indicated via a red tab.

7.3 Data logging (as of **Software version V1.1.0** of the Manager)

Of all Devices in an IQ Easy platform, both an Action log and Datalog are kept. The last logging data can be displayed on the screen. Of the Devices whose "**Data logging**" Parameter is set to "**On**", these are also written to a file. The data is saved in CSV files (Excel format). A separate action log and data log file is generated every day for each Device.

A total of 14 days are stored in the Manager, after which the oldest file is always overwritten / deleted from the system.

7.3.1 Copying data from internal memory to PC

To copy the data log data of the Manager to your PC, the Manager must be connected to a network in which the router has assigned an IP address to the Manager via DHCP.

Make sure that the Manager IQ Easy is connected to a working router during startup of the Manager. Otherwise the Manager IQ Easy must be restarted (power down/up) before the steps below are performed.

Making an FTP connection with a PC or laptop is described in Section 6.22.

Once the connection between the PC or laptop and the Manager IQ Easy has been established, the desired data log files can be copied to the PC or laptop. The data log files are structured in the CSV format, and can be viewed on the PC or laptop with, for example, a program such as Excel and edited if necessary.

7.3.2 Data logging to USB

If the Manager IQ Easy is active and a USB stick is inserted in the USB port of the Manager IQ Easy, the log files present on the system will be copied to the USB stick. This is indicated by the



(Busy) button.

When copying the log files is complete, the following screen will appear.

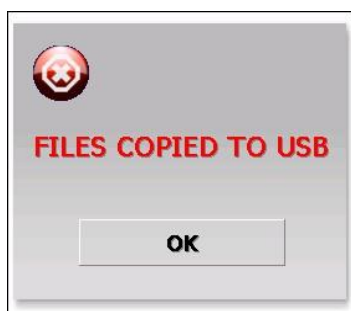

Now remove the USB stick from the USB port and press "**OK**". The screen will now close.

8 Maintenance

The Manager IQ Easy does not require regular maintenance. Keep it clean by not working with dirty fingers. If the display needs to be cleaned, use a commercially available PC screen cleaning cloth.

Check the connection cables regularly for damage. Replace damaged connection cables immediately.

9 Solving malfunctions and problems



Warning:

- The electrical installation must be carried out by an electrical engineer with the relevant training and qualifications.

Table 1, faults

Problem	Cause	Solution
No picture is shown on the display and the Device LEDs do not light up	No supply voltage.	Turn the switch to <i>On</i> .
		Provide 24V DC or 100-230V AC.
		Check the wiring.
No picture is shown on the screen, but the Device LEDs do light up	The Backplane is functioning, but the touchscreen is not.	Check the internal cabling from the Backplane to the touchscreen.
	Touchscreen has crashed	Power down/power up
Pressing buttons on the screen is difficult, just as if you always have to press next to it.	Touchscreen screen calibration is no longer correct.	Calibrate the screen. To do so, please contact your Simco-Ion agent.
A new/extra connected Extension IQ Easy is not found by the Manager IQ Easy.	Communication is not established	Check the wiring.
	Parameter error.	Check the parameter " Rescan Ext.Box timer ". Does this parameter have a value of 15 or 30 seconds?
	Manual search.	Perform action " Scan Ext. Boxes ".
It seems as if the Extension IQ Easy sees that there is communication, but is not found by the Manager IQ Easy.	Communication is not established	Check the wiring.
	Parameter error.	Check the parameter " Rescan Ext.Box timer ". Does this parameter have a value of 15 or 30 seconds?
	Manual search.	Perform action " Scan Ext. Boxes ".
Device is not recognised by Manager	Communication is not established	Check the wiring.
		Detach the device and reconnect (same or other port).
		Set the " Toggle RS485 AB " parameter to " On " and try again.
		Check if a Simco-Ion IQ suitable Device is connected (rating plate)
IQ Device connected to port 5 or 6 doesn't work	Port is configured for Non-IQ (Analogue) Device	Change the Backplane parameter " Port5 Mode " and/or " Port6 Mode " to " Serial ": See Section 06:12.

With a disconnected Device, the “Device Disconnected” message does not appear.	Parameter set incorrectly.	Set parameter “ Popup on disconnected Device ” to “ Yes ”.
		Check Backplane and/or Extension IQ Easy parameter “ Device timeout ”. This may not be set to “ 0 seconds ”. Set to a value like e.g. “ 5 seconds ”.
Device cannot be switched on or off using the screen (icons change, but the Device remains in the same status).	Device is configured to respond to the remote on/off input of the machine control/PLC.	Change the “ Remote on/off source ” parameter to “ Continuous ”.
The IQ Easy system becomes very slow due to many Remote On/Off changes.	Parameter set incorrectly.	Set parameter “ Real-time screen refresh ” to a value between 1 and 5 seconds.
As a Basic user, Devices cannot be put in Run mode.	Incorrect authorisation setting.	Set parameter “ Standby/Run access level ” to “ Basic ”.
As an Advanced user, Devices cannot be put in Run mode.	Incorrect authorisation setting.	Set parameter “ Standby/Run access level ” to “ Advanced ”.
With a Global Run, the Device does not enter Run mode.	Setting error.	Set the Device parameter “ Autorun ” to “ On ”.
Unable to log in as an Advanced user.	Forgot password	Log in as Expert and enter the Advanced password again. See Section 6.17.6, parameter “ Advanced password ”.
It is not possible to log in as an Expert user.	Forgot password	Reset the Expert password. See Section 6.17.7. Then enter the password again. See Section, 6.17.5, parameter “ Expert password ”.
After pairing Devices, the “ Available segments ” parameter shows “ None ” instead of the available segments.		Close the Manager IQ Easy application and then restart it (“ Restart ”), see Section 6.16.
After reconnecting Devices, all Paired Devices are paired incorrectly.	Devices connected to other ports (swapped).	Undo all links between the Paired Devices (see Section 6.18), close the Manager IQ Easy application and restart it (“ Restart ”, see Section 6.16). Then reset all links between Paired Devices (see Section 6.18).
Fieldbus parameters are not visible.	Missing Anybus module.	Place the correct Anybus module in the Manager IQ Easy.
	Backplane software does not support the Anybus.	Loads the right Backplane software for your system.

Fieldbus “ IP Address ” indicates 0.0.0.0.	Fieldbus no address entered.	Give the Fieldbus module a valid network address. See Section 6.31.2.2.
	Network cable not connected.	Connect the network cable and restart the Manager IQ Easy.
	Fieldbus address has been entered. There may be an address conflict.	Check whether a duplicate address has been assigned in the network.
The Fieldbus “ IP Address ” does not match the actual address.	The DHCP server has assigned a new IP address to the Fieldbus module.	Close and restart the Manager IQ Easy.
After starting up, the message “ Invalid shutdown ” is always shown on the screen.	Operator error.	The Manager IQ Easy is switched off in the wrong way. See Section 6.16 for the correct procedure.
	The HMI software has unexpectedly closed.	Check if you are using the latest software version. Update to the latest software version otherwise contact your Simco-Ion agent.
Data is not saved onto the USB flash drive.	USB stick is not recognised.	Power down / power up with USB in the Manager. TODO_RF: I don’t understand this action.
	The connection cable between the HMI and the Backplane has been disconnected.	Check the connection cable between the HMI and the Backplane.
	The USB is formatted with a file system that is not supported by the HMI.	Provide a USB stick with FAT16 file format.
	Folder “log files” is not present in the root path of the USB stick	Create a folder “log files” directly in the root path TODO_RF: The folder is created automatically.
	Message on the screen “ USB IS UPDATE USB ”.	Remove the folder “Update” from the root of the USB stick.
		Format the USB stick. Use a different USB stick.
FTP address is not opened in the browser	Cabling error.	Check the cabling and/or RJ45 connectors.
	Address displayed in settings is an outdated address.	Make sure the Manager IQ Easy is connected to the network, power down, power up and read the IP address again. Enter this address in the browser.
FTP client cannot connect to the Manager IQ Easy.	Wrong IP address used.	Enter the correct IP address of the Manager IQ Easy in the FTP client.
	Wrong username or password used.	Enter the correct username and password in the FTP client.

10 Repairs



Warning:

- Repairs must be carried out by an electrical engineer with the relevant training and qualifications.
- The electrical installation and repair must be carried out by an electrical engineer with the relevant training and qualifications and in accordance with the applicable national and local regulations.

Parts of the Manager IQ Easy cannot be repaired. To order parts, see the spare parts list. Simco-Ion advises you to send the Manager to Simco-Ion for repairs.

An RMA number can be requested by running through the internet form procedure which can be found at <https://www.simco-ion.co.uk/repair/>

Pack the Simco-ION product properly and mention the RMA number clearly on the outside of the package.

11 Scrapping

Observe the applicable local environmental regulations when disposing of the equipment.

OR



At the end of its service life, do not throw the device away with the normal waste but hand it in at an official collection point.
By doing so, you will help to protect the environment.

Spare parts

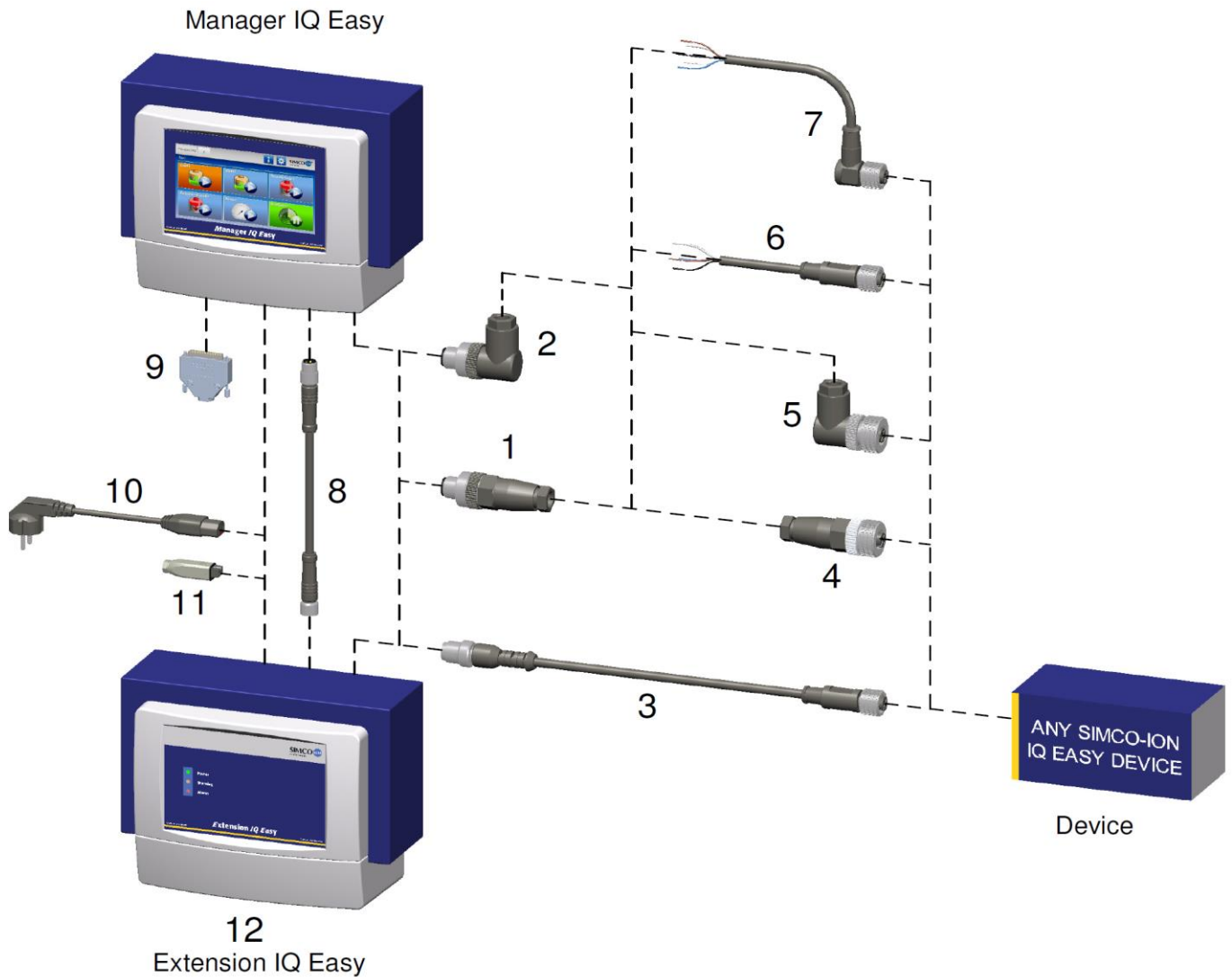

Connectors and connecting cables DEVICES

3	7519020390	Cable Device M12 female-male straight 2 m
	7519020391	Cable Device M12 female-male straight 5 m
	7519020392	Cable Device M12 female-male straight 10 m
	7519020386	Cable Device M12 female-male straight 5 m for protective cable sleeve
	7519020387	Cable Device M12 female-male straight 10 m for protective cable sleeve
	7519020383	Cable Device M12 female-male straight 5 m shielded for protective cable sleeve
	7519020384	Cable Device M12 female-male straight 10 m shielded for protective cable sleeve
1	7519020352	Connector IQ M12 male straight \varnothing 4-6 mm cables
	7519020353	Connector IQ M12 male straight \varnothing 6-8 mm cables
2	7519020357	Connector IQ M12 male right-angle \varnothing 4-6 mm cables
	7519020358	Connector IQ M12 male right-angle \varnothing 6-8 mm cables
4	7519020350	Connector Device M12 female straight \varnothing 4-6 mm cables
	7519020351	Connector Device M12 female straight \varnothing 6-8 mm cables
5	7519020355	Connector Device M12 male right-angle \varnothing 4-6 mm cables
	7519020356	Connector Device M12 male right-angle \varnothing 6-8 mm cables

- | | | |
|---|------------|--|
| 6 | 7519020365 | Cable Device M12 female straight 5 m |
| | 7519020366 | Cable Device M12 female straight 10 m |
| | 7519020380 | Cable Device M12 female straight 10 m shielded for protective cable sleeve |
| 7 | 7519020375 | Cable Device M12 female right-angle 5 m |
| | 7519020376 | Cable Device M12 female right-angle 10 m |

Connecting cables COMM

- | | | |
|---|------------|---------------------------------------|
| 8 | 7519020291 | Cable IQ M8 female-male straight 5 m |
| | 7519020292 | Cable IQ M8 female-male straight 10 m |
| | 7519020294 | Cable IQ M8 female-male straight 25 m |

Other parts

- | | | |
|----|------------|---|
| 9 | 3900236025 | Soldering connector Sub-D 25p male |
| | 3970706910 | Screw connector Sub-D 25p male |
| 10 | 9146340700 | Power cord 230 V IEC-C13, 2 m |
| 11 | 9370000205 | Power connector 24 V, ø4 - 6.5 mm cables |
| 12 | 1030000100 | Extension IQ Easy DC 24V |
| | 1030000110 | Extension IQ Easy AC 100-240V |
| - | 9102502032 | Internal battery Manager IQ Easy 3V (CR2032) |
| - | 4030000000 | Front Panel Manager IQ Easy complete, including HMI |

Spare parts can be obtained from the agent in your region or from SIMCO (Nederland) B.V.

SIMCO (Nederland) B.V.
Aalsvoort 74
NL-7241 MB Lochem, The Netherlands
Telephone +31 (0)573-288333
Email cs@simco-ion.nl
Internet <http://www.simco-ion.nl>